

Operating instructions

PolyLine® Flow ... S

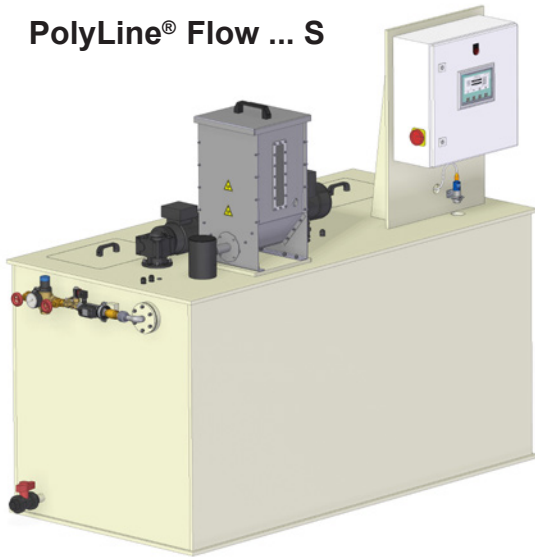

PolyLine® Flow ... SL

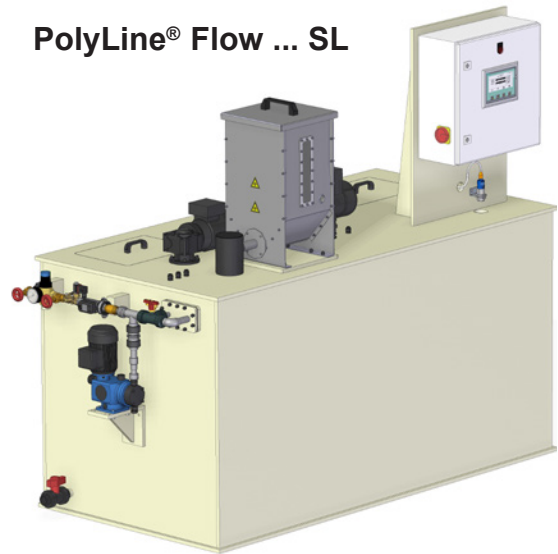

PolyLine® Flow ... L

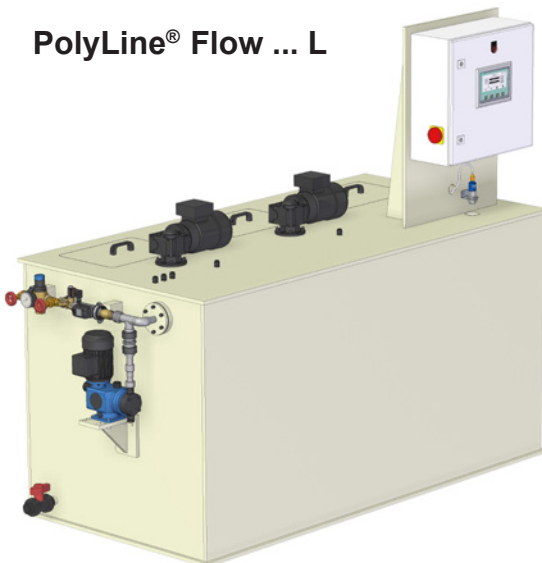

Manufacturer:

sera GmbH
 sera-Straße 1
 34376 Immenhausen
 Germany
 Tel.: +49 5673 999-00
 Fax: +49 5673 999-01

info@sera-web.com
www.sera-web.com

Keep the operating manual for future use!

Record the exact type and serial number here.
 (can be read off the type plate on the dosing unit)

Type :

Serial No. :

These data are important in the case of queries or for ordering spare and/or wear parts and must always be stated.

Operating instructions

Operating instructions



NOTE!

Project-specific documents such as product description and test certificates are not an integral part of the CD contents.



Operating instructions

Table of contents

1. General information	6
1.1 General user instructions	6
1.2 Marking of notes in this operating manual.....	6
1.3 Marking of notes on the product.....	6
1.4 Quality notes	7
1.5 Utilities.....	7
1.6 Water quality.....	7
1.7 Design data	7
2. Safety instructions	8
2.1 Personnel qualification and training	8
2.2 Dangers in the case of non-observance of the safety instructions.....	8
2.3 Safety conscious working.....	8
2.4 Safety instructions for the owner / operator.....	8
2.5 Safety instructions for maintenance, inspection and installation work	8
2.6 Unauthorised modification.....	8
2.7 Improper operation	9
2.8 Intended use.....	9
2.9 Personal protection equipment for maintenance and repair.....	9
2.10 Foreseeable misuse	10
2.10.1 Transport	10
2.10.2 Installation	10
2.10.3 Commissioning.....	10
2.10.4 Operation	11
2.10.5 Maintenance / repair	11
2.10.6 Cleaning	11
2.10.7 Dismantling	11
2.10.8 Disposal	11
2.10.9 Decommissioning.....	11
3. Transport and storage	12
3.1 General.....	12
3.2 Transport.....	12
3.3 Storage.....	12
4. Product description	13
4.1 Types	13
4.1.1 Type code.....	13
4.1.2 Type plate.....	13
4.1.3 Materials.....	14
4.2 Functional description	14
4.3 Supply unit design	16
4.4 Options	17
5. Technical Data	18
5.1 Technical Data	18
5.2 Electrical data.....	18
5.3 Dimensions	19
5.3.1 PolyLine® Flow ... SL.....	19
5.3.2 PolyLine® Flow ... L	20
5.3.3 PolyLine® Flow ... S.....	21
6. Assembly / Installation	22
6.1 Installation	22
6.2 Installation location.....	22
7. Electrical connection	23

Operating instructions

8. Control system	23
8.1 General operating instructions	23
8.1.1 <i>Touch panel operation</i>	24
8.2 Start screen	25
8.3 Automatic mode	26
8.3.1 <i>Process control</i>	27
8.4 Parameters	28
8.4.1 <i>Settings (parameter)</i>	32
8.5 Service mode	33
8.6 Setup mode	36
8.6.1 <i>Water flow rate adjustment</i>	37
8.6.2 <i>Hopper empty signal empty adjustment (option)</i>	37
8.6.3 <i>Hopper empty signal full adjustment (option)</i>	38
8.6.4 <i>DMF (dry material feeder) calibration</i>	38
8.6.5 <i>Calibration pump</i>	40
8.7 Summation counter	40
8.8 System settings	42
8.9 Error messages	44
8.10 Exchange of signals	45
9. Commissioning	46
9.1 Function description of wide angle nozzle	48
10. Maintenance	49
11. Decommissioning	51
12. Restarting	51
13. Fault analysis and corrective action	51
14. Disposal	51
14.1 Removal and transport	52
14.2 Complete disposal	52
15. Documentation of the system parts	52
16. Clearance Certificate	53

Operating instructions

1. General information





1.1 General user instructions

The applicable regulations for the installation site must be observed before the commissioning and during the operation of this **sera** product.

This **sera** product is delivered ready for connection. Carefully read these instructions and particularly the safety instructions before installation and commissioning.

1.2 Marking of notes in this operating manual

Special notes in these operating instructions are marked with text and danger symbols.

Designation of the note (Text and symbol)	Danger type			Definition of the note (in the operating instructions)
	Danger of fatal injury	Risk of injury	Damage to property	
DANGER! 	X	X	X	Identifies an imminent danger that results in fatal or severe injuries if not avoided.
WARNING! 	X	X	X	Designates a potentially dangerous situation There might be danger to life or serious injury and damage to property if it is not avoided.
CAUTION! 		X	X	Designates a potentially dangerous situation There might be slight or minor injury or damage to property if it is not avoided.
ATTENTION! 			X	Designates a potentially dangerous situation that could lead to damage to property if not avoided.
NOTE! 				Designates information which helps to make work easier and is useful for trouble-free operation.

1.3 Marking of notes on the product

Symbols which are directly attached to the pump, e.g. arrows for direction of rotation or symbols for fluid connections are to be observed and kept in legible condition.

Operating instructions

1.4 Quality notes

Observance of these operating instructions and, in particular, the safety instructions, helps to:

- Avoid dangers to persons, machines and environment.
- Increase reliability and service life of the product and the complete system.
- Reduce repair cost and downtime.

The **sera** quality management and quality assurance system for pumps, systems, valves and fittings and compressors is certified according to ISO 9001:2008.

The **sera** product meets the valid safety and accident prevention regulations.



ATTENTION!

Always keep these operating instructions within reach at the place of installation.



WARNING!

Pay attention to the safety data sheet of the medium! The owner must take corresponding accident prevention measures to protect operating personnel from danger through the delivery media used!

1.5 Utilities

If not agreed otherwise in the contract conditions, the **sera** dosing station will always be supplied with the necessary utilities. (Type and quantity of the utilities / lubricants are stated in the operating instructions of the pumps and valves).

1.6 Water quality

Water used for commissioning, maintenance and shutting down must be similar to drinking water, i.e. chemically neutral, free from solid and suspended matter and interfering ion concentrations.

1.7 Design data

Medium	End product polymer solution max 1%
Viscosity	End product max. 500 mPas
Working temperature	5 °C to 40 °C
Solid matter	none
Installation	indoors, no direct sunlight
Design pressure	1-6 bar water pressure (depressurised tank)

Operating instructions

2. Safety instructions

2.1 Personnel qualification and training

The personnel for operation, maintenance, inspection and installation must be suitably qualified for their tasks. The owner must clearly define responsibility and supervision of the personnel. If the personnel do not have the knowledge required, then personnel is to be trained and instructed correspondingly. Such training can be provided by the manufacturer / supplier upon order of the owner. In addition, the owner has to ensure that personnel have understood the operating instructions completely.

2.2 Dangers in the case of non-observance of the safety instructions

Inobservance of these safety instructions can result in danger to persons, hazards to the environment and damage to the product.

Inobservance of the safety instructions may lead to:

- Failure of important functions of the product/system.
- Inobservance of prescribed methods for maintenance and servicing.
- Danger to persons through electrical, mechanical and chemical influences.
- Hazards to the environment through leaking dangerous media.

2.3 Safety conscious working

The safety instructions specified in this operating manual, the national regulations for accident prevention, the safety regulations for the pumped medium valid at the place of installation as well as internal working-, operating-, and safety instructions of the owner are to be observed.

2.4 Safety instructions for the owner / operator

Leaking hazardous delivery media and operating supplies are to be disposed off in such a way that any danger to persons and the environment is excluded. The legal regulations are to be observed.

Danger caused by electrical energy is to be avoided.

2.5 Safety instructions for maintenance, inspection and installation work

The owner must ensure that any maintenance-, servicing- and installation work is only entrusted to authorized and suitably qualified personnel who have carefully read and understood the operating instructions.

Only those spare parts and operating supplies are to be used which meet the requirements of the specified operating conditions.

Threaded joints and connections may only be disconnected when the system is not under pressure.

2.6 Unauthorised modification

Modifications of or changes to the pump are only permitted after previous agreement of the manufacturer. Original spare parts and accessories which were approved by the manufacturer are essential for safety reasons.

Operating instructions



CAUTION!

If the pumps (e.g. drive motor) are modified without authorization of the manufacturer or spare parts are used which are not approved, any warranty claim becomes null and void.

2.7 Improper operation

Operating safety of the supplied product is only guaranteed if the product is used as intended, according to the descriptions in Chapter "Intended use" of these operating instructions.

2.8 Intended use

The **sera** product is only to be deployed according to the intended purpose stated in the product description and the acceptance test certificate.

If the product is to be used for other applications, then the suitability of the product for the new operating conditions must be discussed with sera beforehand!

Criteria for operation in accordance with the intended use:

- Observe characteristics of the medium (please see safety- and product data sheet of the delivery medium – the safety data sheet is to be provided by the supplier / owner of the medium).
- Resistance of the materials which come into contact with the medium.
- Operating conditions at the place of installation.
- Pressure and temperature of the medium.
- Voltage supply.

2.9 Personal protection equipment for maintenance and repair

The provisions of the German Ordinance on Hazardous Substances (GefStoffV) (§14 Safety Data Sheet) and relevant national safety regulations for the pumped medium must strictly be adhered to.

In case of accidents check whether the following substances are emitted:

- Leaking fluids.
- Leaking vapours.
- Noise emissions (sound level).

Emissions are to be monitored by corresponding control systems of the total installation.



ATTENTION!

Wear protective clothing, gloves, breathing mask and a face protecting mask.



NOTE!

Personal protective equipment must be provided by the owner!



NOTE!



Operating instructions

2.10 Foreseeable misuse

The following misuse is assigned to the life cycles of the machine.



DANGER!

Misuse can result in danger to the operating personnel!

2.10.1 Transport

- Load not sufficiently secured during transport.
- Transport by untrained personnel.
- Tipping behaviour during transport, loading and unloading ignored.
- Weight for lifting underestimated.
- Climbing on the system.

2.10.2 Installation

- Installation of the system at an improper site (outside, direct sunlight, explosion-hazardous area etc.).
- Confusion of the suction and pressure pipes.
- Threads overturned/damaged.
- Piping bent when it was mechanically connected.
- Non-compliant electrical connection (without ground wire, mains not fuse-protected etc.).
- Inside soiling of the tank.
- Stepping on the tank (e.g. as climbing aid).
- Modification to another tank.
- Installation on an unsuitable surface (e.g. inclined surface).
- Improper fastening (e. g. screwing of the tank bottom).

2.10.3 Commissioning

- Non-observance of the design data/operating conditions (medium, pressure, suction height, temperature etc.).
- Non-observance of the electrical characteristics (motors, sensors).
- Cover on vent openings (motor).
- Closed suction and pressure pipes.
- Conveyance of a wrong medium.
- Maladjustment/damage of the level meters.
- Too high a back pressure.
- Pumped medium too warm ► failure of material.
- Tank overfilled.
- Sensor cable removed.
- Conveyance without connected pressure pipe.
- Test run without cover.

Operating instructions

2.10.4 Operation

- Operation of the pump/overflow valve with defective diaphragm.
- Ignoring of a pump fault.
- Operating the machine outside its designed limits for use.
(exceeding the rated pressure, pressure peaks, contaminated medium (with particles)).
- Sudden closure of the pressure pipe.
- Suction pipe clogged.
- Operation with open cover.
- Personnel not familiar with handling of the pump.
- Wrong pumped medium.
- Tank overfilled.
- Conveyance without connected pressure pipe.

2.10.5 Maintenance / repair

- Disregard of the maintenance schedule according to the operating instructions.
- Improper maintenance.
- Use of non-original spare parts.
- Insufficient rinsing before maintenance work.
- Use of cables with damaged insulation.
- Valves confused.
- Pipes not connected.

2.10.6 Cleaning

- Protective equipment insufficient or missing.
- Wrong rinsing/cleaning agent.
- Use of unsuitable cleaning utensils.
- Rinsing/cleaning agent residues in the system.
- Tank turned over for discharge.
- Vent openings clogged.

2.10.7 Dismantling

- Repair work by untrained personnel.
- Improper execution of repair work.

2.10.8 Disposal

- Improper disposal of the pumped medium, consumables and materials.

2.10.9 Decommissioning

- Insufficient removal of the pumped medium from the pipes with subsequent rinsing.
- Removal of pipes with the pump running (residual pressure).
- Disconnection from the power supply not ensured.

Operating instructions

3. Transport and storage

3.1 General

sera products are checked for faultless condition and function before shipment.

The packaging will be in accordance with the transport conditions. The transport is upright on a pallet. The products are packed according to the transport conditions. The system is transported upright on the available grating.

The customer must check the product for transport damage immediately after receipt. If any damage is detected, this must be reported immediately to the responsible carrier and to the supplier.

The unit should only be transported using suitable means of transport or hoists. Pay attention to the weight of the system and the load-bearing capacity.

3.2 Transport



WARNING!

The accident prevention regulations must be observed for transport and shunting.



DANGER!

Keep a sufficient distance from high-tension lines when transporting the system.



WARNING!

Check the system for loose parts.
Fasten loose parts for transport!



CAUTION!

Be careful when lifting the system. Pay attention to the centre of gravity!
Fasten the system sufficiently! The unit must only be transported using suitable lifting gear!

3.3 Storage

An undamaged packaging protects the unit during storage and should only be opened when the product is installed.

Proper storage increases the service life of the product and includes prevention of negative influences such as heat, moisture, dust, chemicals etc.

The following storage specifications are to be observed:

- Storage place: cool, dry, dustfree and slightly ventilated
- Storage temperature between -10°C and +45°C
- Relative air humidity not more than 50 %.
- The maximum storage time for the standard system is 12 months.

If these values are exceeded, metal products should be sealed in foil and protected from condensation water with a suitable desiccant.

Do not store solvents, fuels, lubricants, chemicals, acids, disinfectants and similar in the storage room.

Operating instructions

4. Product description

4.1 Types

4.1.1 Type code

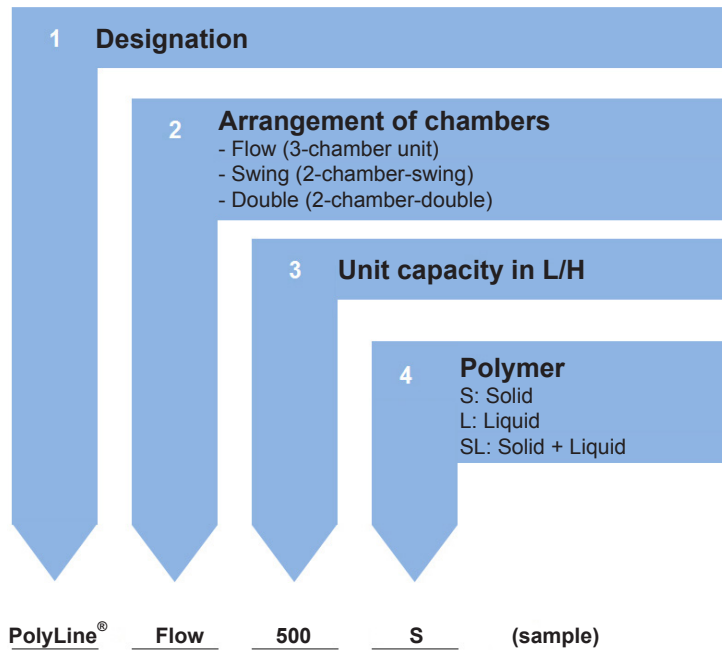

4.1.2 Type plate

Every **sera** dosing station is factory provided with a type plate. The following information can be found on this type plate.

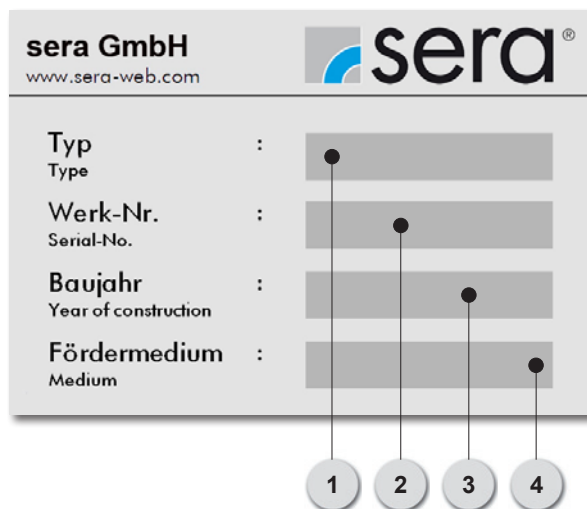

1	Type of the dosing station
2	Serial number of the dosing station
3	Year of construction of the dosing station
4	Pumped medium

Operating instructions

4.1.3 Materials

The suitability of the materials for the medium must be ensured by the owner. The following materials are used:

PP:	tank
PVC-U:	ball cocks
FPM:	tank seal (ball cocks)
Brass:	water supply fittings
Stainless steel:	DMF case

4.2 Functional description

The preparation of the polymer solution is controlled by a programmable logic controller (PLC) in combination with a control panel.

The system can be operated automatically or manually. In automatic mode, the preparation is performed completely automated and/or by external enable. The water quantity needed for the preparation process is set at the valves in the process water supply. Manual mode is used for service purposes whereby all units can be actuated individually. For removal chamber (9) of the tank (6), the fill levels are recorded using a continuous ultrasonic sensor (5) and evaluated by the control system (4). The removal chamber can optionally be implemented with overflow protection using capacitive sensors with WHG (German Water Resources law) approval.

System alarm messages are displayed as plain text on the control panel. A distinction is made between warnings and faults whereby the latter are also signalled by a "group fault" indicator lamp. The messages remain present until they are acknowledged at the control panel and their causes have been eliminated. There is also a potential-free switching contact available which wire the group fault of the system on the terminal block.

When using polymer in powder form, the finished solution is realised by adding this using a dry material feeder (DMF) (3). The feed hopper of the DMF can optionally be fitted with a capacitive limit switch to be able to output an "empty" signal.

In order to prevent lumping or bridging at the two discharge points of the DMF, these are fitted with a heating ring which is always switched on during operation of the system. The polymer dosing is performed proportionally to the water quantity (dosing pulse) in order to also guarantee an approximately constant concentration of the preparation in the event of a fault. The dosing pulse here can be set customer-specifically to a multiple of the flow sensor. The running time of the DMF is determined from the preparation concentration and the conveying capacity of the dry material feeder. The latter requires calibration of the dry material feeder which must strictly be performed individually for both conveying directions.

The concentrate is produced with a pump when using liquid polymer. The system owner must ensure sufficiently filled delivery containers of the liquid polymer here. In this case, the polymer is added by the injection in proportion to the water quantity into the piping of the system. The running time of the addition is determined from the preparation concentration (effective amount of the liquid polymer used) and the delivery rate of the concentrate pump. The latter requires calibration of the concentrate pump.

The process is started with preparation chamber (7) at the beginning of the automatic preparation. This is first filled with an initial charge of water until the fill level of the agitator (2) lock (LSZL) is reached. In the next step, the polymer addition is started depending on the system variant and is controlled proportionally to the continuous inflowing water quantity.

The prepared polymer solution flows automatically into the maturing chamber (8), the mature product reaches the removal chamber (9).

As soon as the LS+ fill level in the removal chamber is reached, the addition of polymer and water is stopped and the preparation complete. The agitators continue to be switched on here until expiry of the maturing time (run-on time) and then changes to pulse-pause mode which can be parametrised customer-specifically. If no pulse / pause time is set, the agitators remain switched off until the start of a new preparation.

As soon as the MIN-level in the removal chamber is reached again, the new preparation starts automatically.

Operating instructions

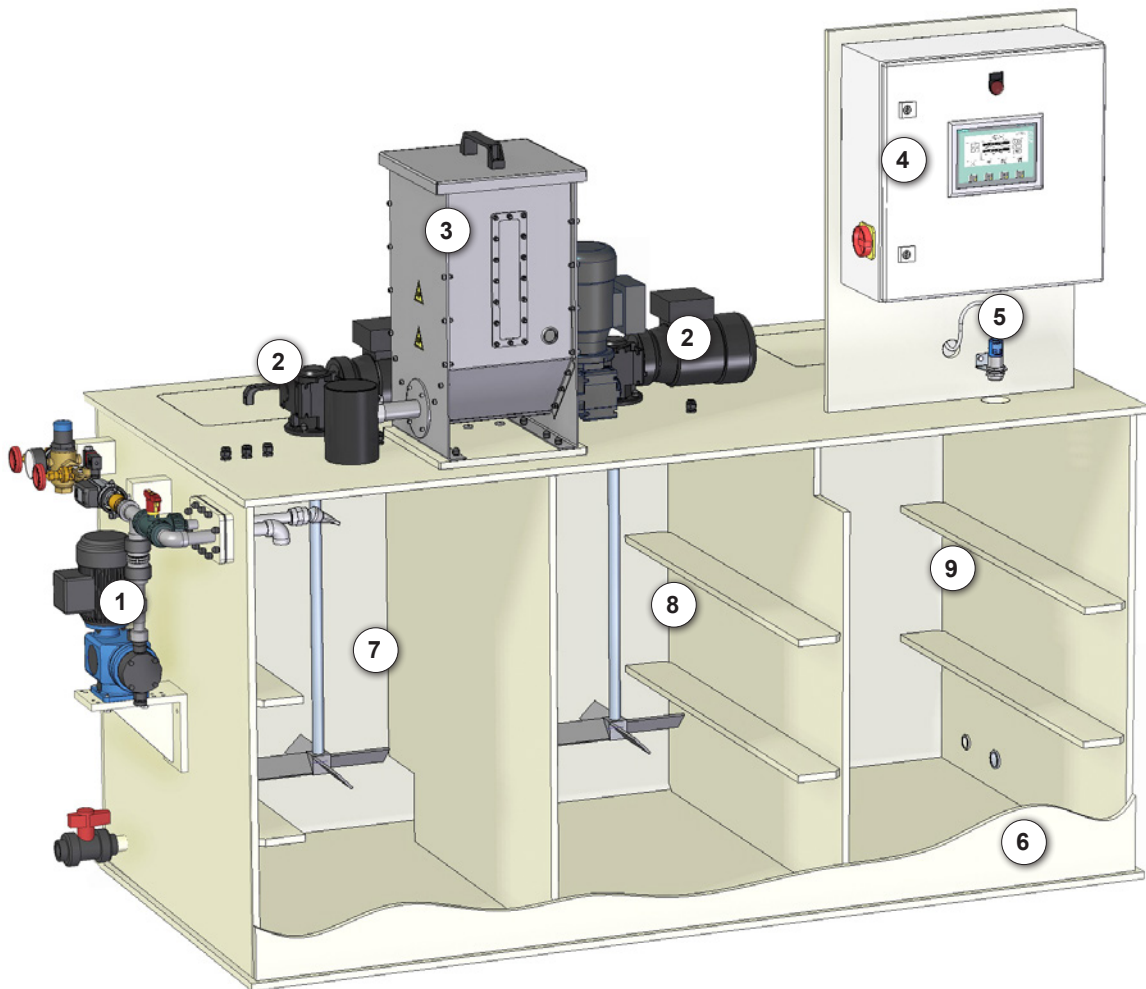

No.	Designation
1	Supply unit
2	Electric agitator MU...
3	Dry material feeder DMF...
4	Control system
5	Continuous ultrasonic sensor
6	Tank
7	Preparation chamber
8	Maturing chamber
9	Removal chamber

Operating instructions

4.3 Supply unit design

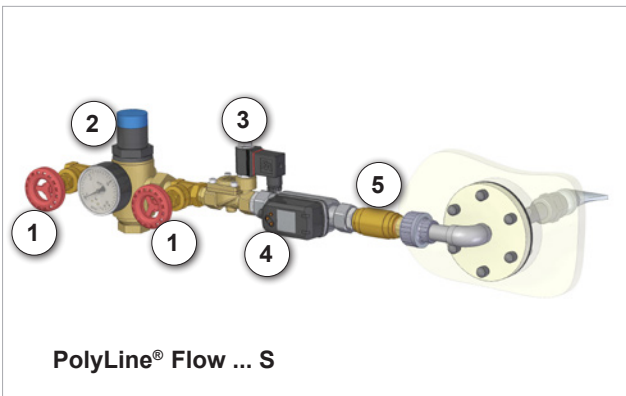
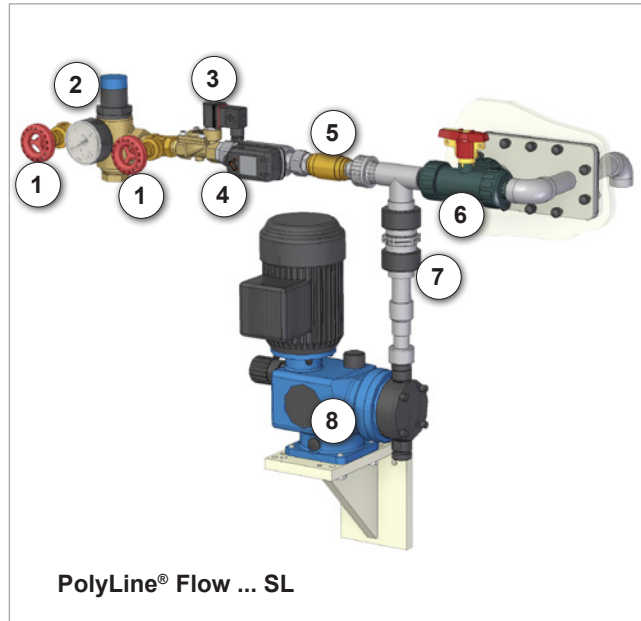
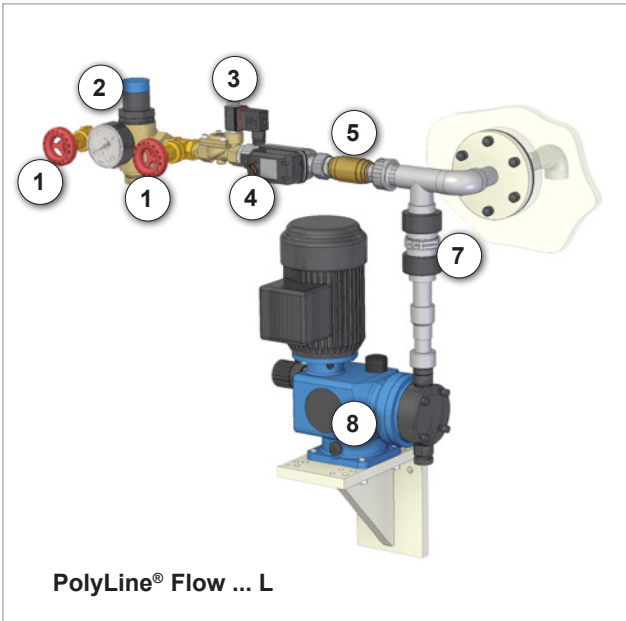

No.	Designation
1	Gate valve
2	Pressure reducer with manometer
3	Solenoid valve
4	Flow sensor
5	Check valve
6	Ball cock
7	Dosing valve
8	Pump

Operating instructions

4.4 Options

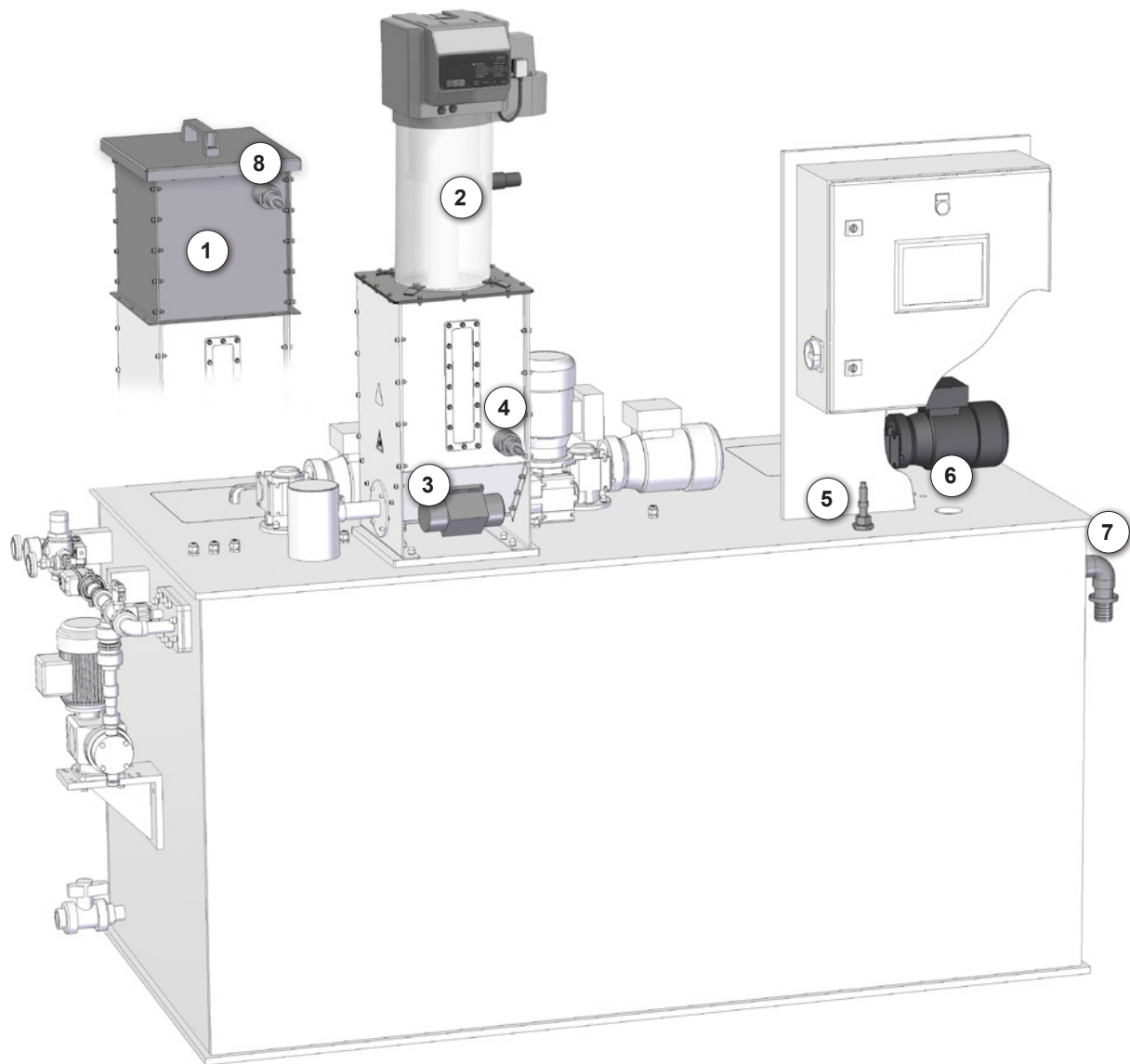

No.	Designation
1	Hopper extension *
2	Conveying system *
3	Vibrator *
4	Sensor empty signal for hopper *
5	Overflow protection
6	Electric agitator
7	Overflow
8	Sensor full signal for hopper *

* See the operating instructions dry material feeder DMF.

Operating instructions

5. Technical Data

5.1 Technical Data

PolyLine®	Variant ¹⁾	Weight appr. kg	System volume L	Preparation concentra- tion %	Maturing time min	Viscosity mPas	System performance ²⁾ L/h
500	S	225	500	0,05...1	45	500	500
	L	210					
	SL	245					
1000	S	225	1000	0,05...1	45	500	1000
	L	210					
	SL	245					
2000	S	260	2000	0,05...1	45	500	2000
	L	240					
	SL	275					
4000	S	440	4000	0,05...1	45	500	4000
	L	420					
	SL	465					
8000	S	740	8000	0,05...1	45	500	8000
	L	720					
	SL	765					

¹⁾ System variants: S ► Solid polymer, L ► Liquid polymer, SL ► Solid and liquid polymers

²⁾ depending on polymer and maturing time

5.2 Electrical data

Supply voltage	Control voltage	Type of protection	
		Switch cabinet	Electrical consumers
3 / 400 V / 50/60 Hz + N +PE	24 V DC	IP 54	IP 55

Operating instructions

5.3 Dimensions

5.3.1 PolyLine® Flow ... SL

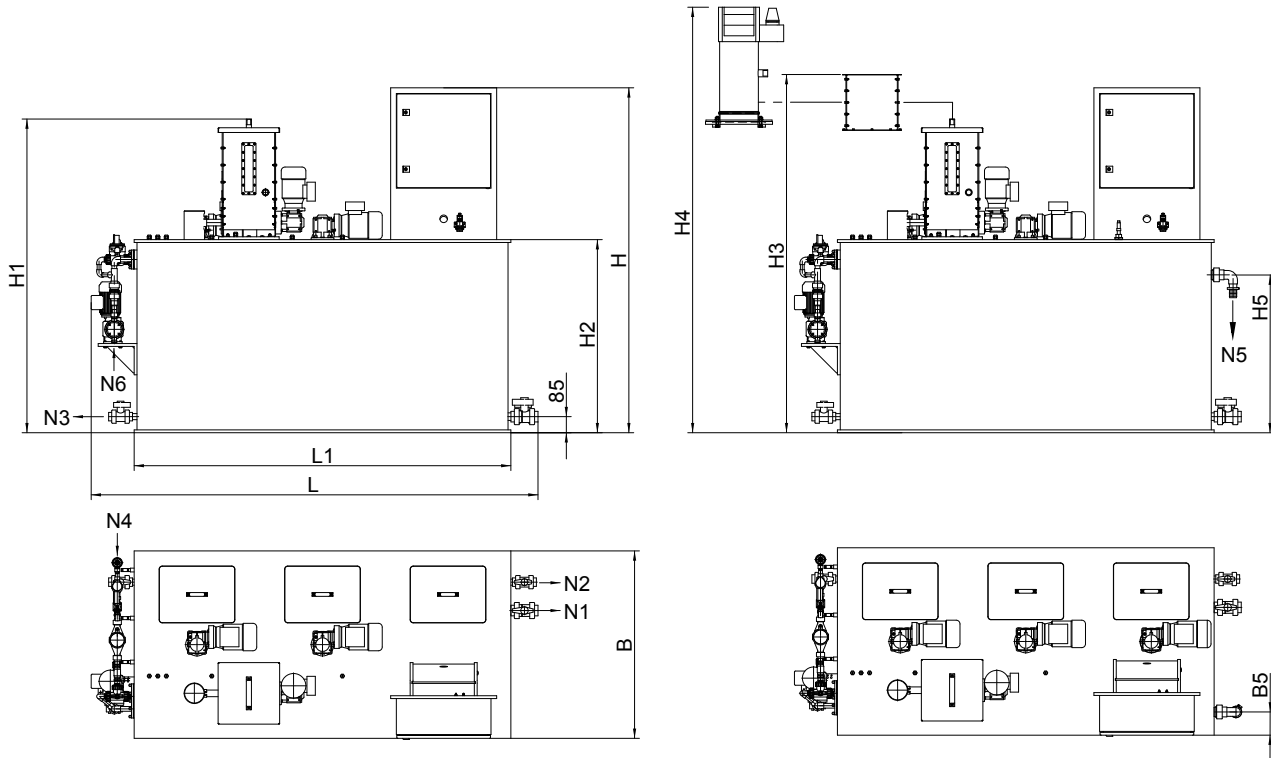

		PolyLine® Flow ... SL					
		500	1000	2000	4000	8000	
standard	B	990	990	990	1280	1570	
	H	1552	1552	1822	2112	2327	
	H1	1387	1387	1657	1947	2162	
	H2	750	750	1020	1310	1525	
	L	2367	2367	2360	3426	4467	
	L1	1990	1990	1990	2990	4000	
	N1	product removal	DN25	DN25	DN32	DN40	DN50
	N2	tank draining	DN25	DN25	DN25	DN25	DN25
	N3	tank draining	DN25	DN25	DN25	DN25	DN25
	N4	water supply	DN15 / IG1/2	DN15 / IG1/2	DN15 / IG1/2	DN15 / IG1	DN15 / IG1
option	N5	overflow	DN32	DN32	DN32	DN50	DN50
	B5	overflow	120	120	120	120	120
	H5	overflow	670	670	940	1230	1448
	H3	hopper extension	1636	1636	1906	2196	2414
	H4	conveying system	1968	1968	2235	2525	2743

Operating instructions

5.3.2 PolyLine® Flow ... L

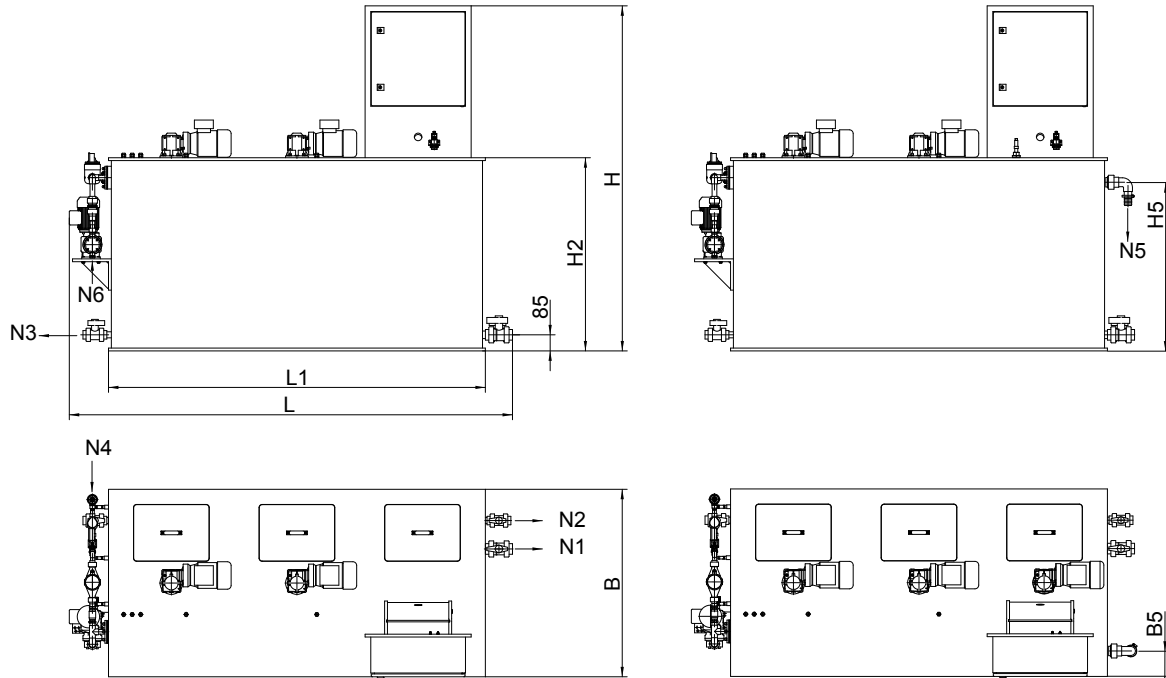

		PolyLine® Flow ... L					
		500	1000	2000	4000	8000	
standard	B	990	990	990	1280	1570	
	H	1552	1552	1822	2112	2327	
	H2	750	750	1020	1310	1525	
	L	2347	2347	2340	3378	4420	
	L1	1990	1990	1990	2990	4000	
	N1	product removal	DN25	DN25	DN32	DN40	DN50
	N2	tank draining	DN25	DN25	DN25	DN25	DN25
	N3	tank draining	DN25	DN25	DN25	DN25	DN25
	N4	water supply	DN15 / IG1/2	DN15 / IG1/2	DN15 / IG1/2	DN15 / IG1	DN15 / IG1
option	N6	polymer supply	DN5 (G3/4)	DN5 (G3/4)	DN8 (G3/4)	DN8 (G3/4)	DN15 (G1)
	N5	overflow	DN32	DN32	DN32	DN50	DN50
	B5	overflow	120	120	120	120	120
	H5	overflow	670	670	940	1230	1448

Operating instructions

5.3.3 PolyLine® Flow ... S

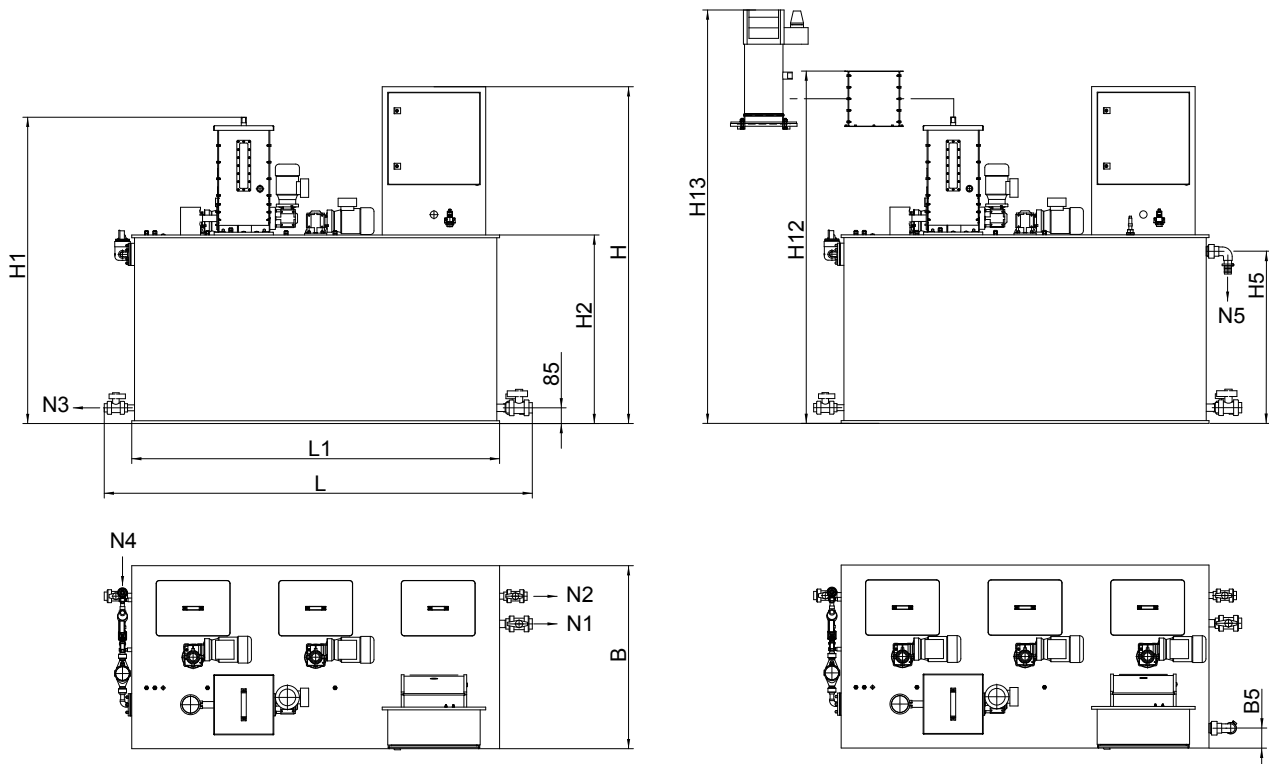

		PolyLine® Flow ... S					
		500	1000	2000	4000	8000	
standard	B	990	990	990	1280	1570	
	H	1552	1552	1822	2112	2327	
	H1	1387	1387	1657	1947	2162	
	H2	750	750	1020	1310	1525	
	L	2290	2290	2316	3314	4328	
	L1	1990	1990	1990	2990	4000	
	N1	product removal	DN25	DN25	DN32	DN40	DN50
	N2	tank draining	DN25	DN25	DN25	DN25	DN25
	N3	tank draining	DN25	DN25	DN25	DN25	DN25
	N4	water supply	DN15 / IG1/2	DN15 / IG1/2	DN15 / IG1/2	DN15 / IG1	DN15 / IG1
option	N5	overflow	DN32	DN32	DN32	DN50	DN50
	B5	overflow	120	120	120	120	120
	H5	overflow	670	670	940	1230	1448
	H3	hopper extension	1636	1636	1906	2196	2414
	H4	conveying system	1968	1968	2235	2525	2743

Operating instructions

6. Assembly / Installation

6.1 Installation

The following points must be observed for installation of the system:

- Check the complete dosing system for damage (e.g. due to breakage).
- The system is designed for indoor installation and must be protected from direct sunlight.
- Build in the dosing system and attach with appropriate material.
- The piping on the suction and pressure side must be sufficiently dimensioned.
- Connect all pipes and make sure that they are tension- and vibration-free. Offset of the pipes in the area of the screw connections must be strictly avoided.
- The electrical connections must be made in accordance with the VDE (Association of German Electrotechnical Engineers) or the local applicable electrical regulations. See also Chapter "Electrical connection".

6.2 Installation location

- The place of installation must be frostproof and vented.
- An installation in an aggressive or explosion-hazardous area is not permitted.
- The design data according to the Appendix must be taken into account.
- The installation location must be equipped with proper lighting for all work (installation, operation, maintenance etc.).
- Leaking chemicals must be disposed of in a safe and secure manner at the installation site.



ATTENTION!

The fastening material is not included in the scope of delivery of the system and must be provided by the customer depending on the condition of the floor!

Operating instructions

7. Electrical connection

Perform electrical connection of the system according to the system design (see "Product description" in the Appendix) and the circuit diagram on the supplied data carrier.



ATTENTION!

The electrical connection must only be done by qualified personnel.
The local safety regulations must be observed.



ATTENTION!

Have the electrical installation checked by the responsible safety officer after completion of the work. Carry out an insulation measurement if necessary!

8. Control system

8.1 General operating instructions

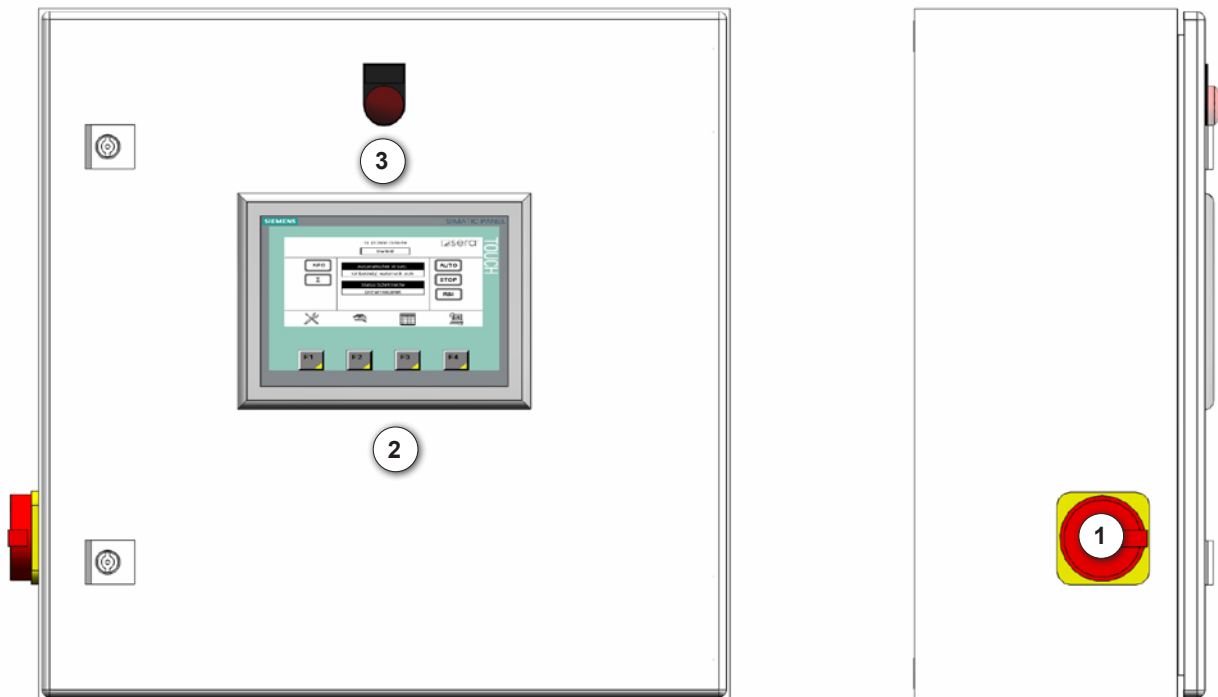

- 1 - Main switch
- 2 - HMI control panel
- 3 - Indicator lamp "group fault"

Operating instructions

8.1.1 Touch panel operation

Touch objects are contact-sensitive operating objects on the screen of the control panel, e.g. buttons, IO fields and message windows. Their operation basically is no different from pressing conventional buttons. Touch objects are operated by a finger touch.



ATTENTION!

Always touch only one spot on the screen. Do not touch several touch objects simultaneously. This may result in unintentional actions.





ATTENTION!

Do not use any pointed or sharp-edged objects for operation as the plastic surface of the touch screen may be damaged.

Input / output fields (IO fields)

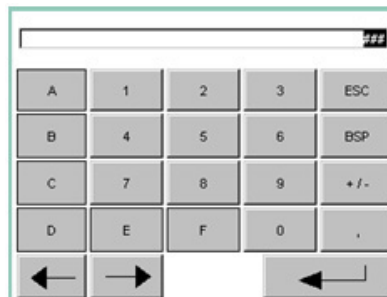
When you touch an IO field an on-screen keyboard will be displayed as feedback.



Input the desired value and confirm with the  button. Afterwards, the value will be taken over in the controller. The value input can be cancelled with the ESC button.

Buttons

Buttons are displayed differently for “touched” and “not touched”.



Operating instructions

8.2 Start screen

The following start screen is displayed after switching on the controller.

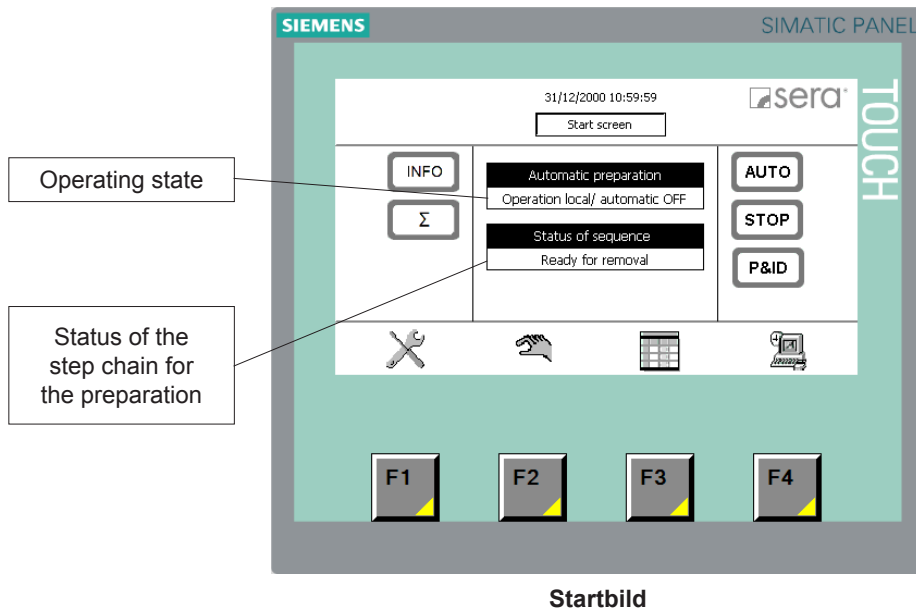

Button	Description
F1	Call setup mode
F2	Call service mode
F3	Call parameters page
F4	Call system control



NOTE!

Call help text in the respective window with the button "INFO" or "i"

Operating instructions

8.3 Automatic mode

Automatic operation is activated in the start screen with the "AUTO" button and switched off with the "STOP" button. In automatic mode, the preparation of the polymer solution is performed automatically depending on the level in the removal chamber.

The external enable for the preparation is also required in remote operation.

Notes:

- The automatic preparation goes into pause mode after removal of the external enable.
- The preparation continues if the signal is present again.
- The step chain is reset when automatic operation is switched off.
 - i.e., after the restart, the level in the removal chamber is assessed again and the preparation is started accordingly.
- The last active preparation is cancelled after switching on the power supply again. Automatic mode stays switched on. Afterwards, the level in the removal chamber is assessed again and the preparation is started accordingly.

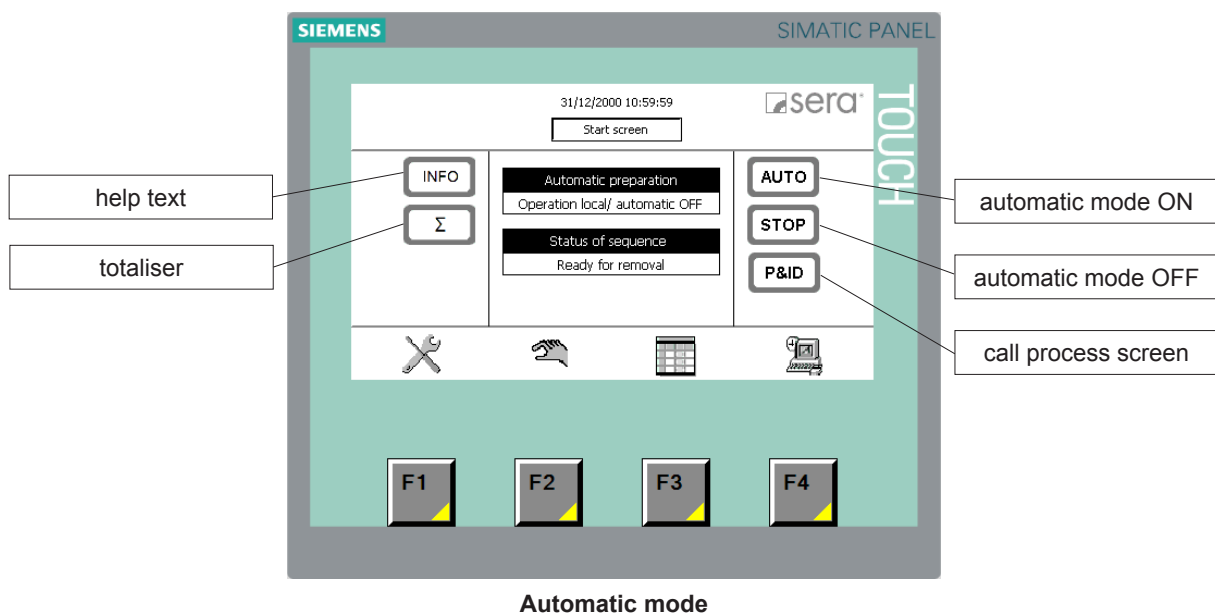

Operating instructions

8.3.1 Process control

The process screen is invoked by pressing the P&I button. This screen shows the schematic diagram of the 3-chamber polymer solution preparation system. Active modules are shown as filled-in fields.

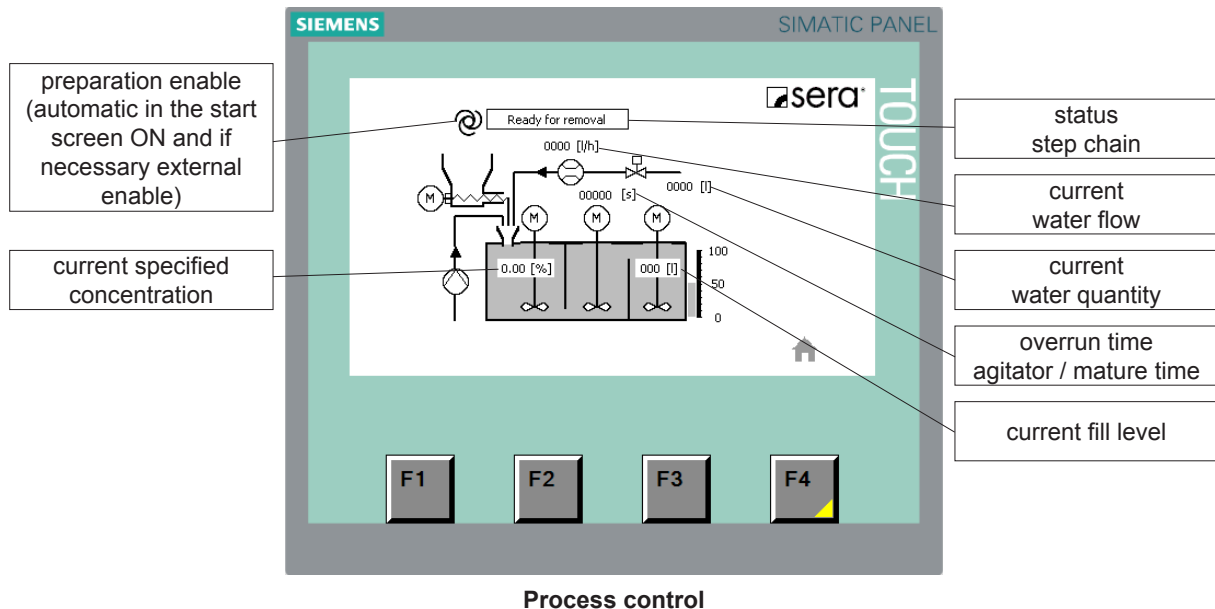

Image above shows optional equipment!

NOTE!

Step chain status

Display	Description
Preparation OFF	No preparation active
pause	Preparation interrupted
Ready for removal	Level in removal chamber above LS-
Inlet	Dilution water inlet (induction hopper wetting)
Preparation running...	Preparation active
Overrun	Dilution water overrun (rinsing)
Agitator overrun / mature time	Overrun time of the agitators / mature time

Automatic preparation process:

- Start automatic preparation with undercutting of level LS- in removal chamber.
- Dilution water solenoid valve opens.
- After filling the air eliminator quantity, the polymer addition starts proportional to the water flow.
- Agitator in preparation chamber starts.
- Agitator in maturing chamber starts if Agitator 2 parameter is set to "Preparation ON".
- The polymer addition stops when the level LS+ in the removal chamber is exceeded.
- After filling the overrun quantity, the solenoid valve for the dilution water closes.
- The overrun time for the agitator starts afterwards.
- Agitator in maturing chamber starts if Agitator 2 parameter is set to "Preparation OFF".
- After the overrun time / mature time has elapsed, the agitators go into pulse-pause mode or are switched off depending on the set parameters.

Operating instructions

8.4 Parameters

The parameter pages are called up on the start screen by pressing the F4 button. Editing the parameters is password-protected.

Parameters with grey background IO field can be changed. Parameters with white background field cannot be changed; these are only used for display / output.



Parameters may only be changed when Automatic mode is deactivated.

ATTENTION!

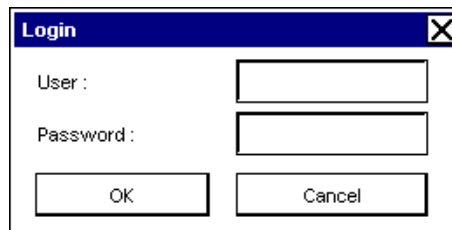

User: USER02
Password: 9021

After logging in correctly, the value to be changed must be clicked on again.

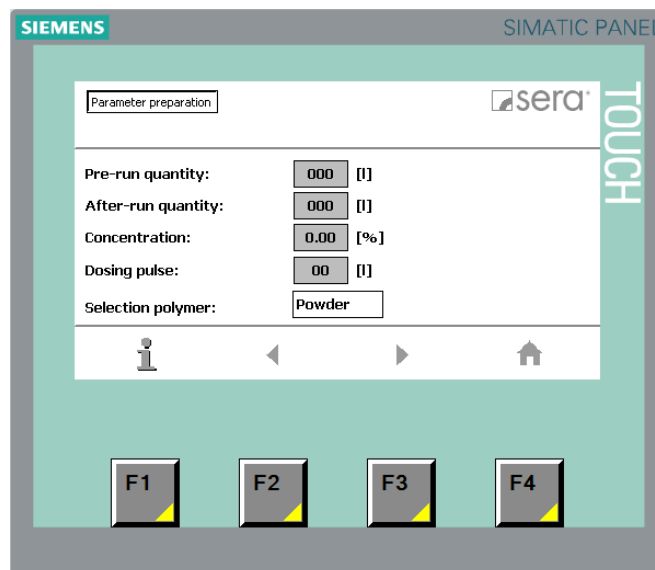

Parameter preparation

Parameters	Description	Value
Inlet volume	Inlet volume in litres for wetting the induction hopper with dilution water.	
Overrun quantity	Overrun quantity for rinsing the induction hopper after ending the preparation	
Preparation concentration	Concentration of the finished ready to use solution	
Dosing pulse	The dosing pulse starts the addition of polymer. This value must be selected depending on the water flow and the concentration (the higher the concentration, the higher the addition of polymer).	
Selection polymer	Select polymer type, liquid or powder (only by SL-, L- design)	

Button	Description
F1	Call information page
F2	Back
F3	Next
F4	Start screen

Operating instructions

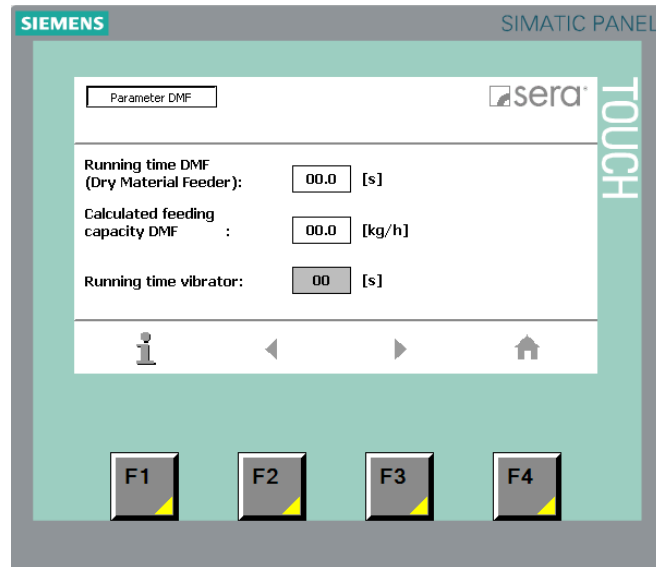

Parameter DMF

Parameters	Description	Value
Running time DMF (dry material feeder)	Calculated running time of the DMF depending on the concentration, calculated conveying capacity of the DMF and the dosing pulse.	
Calculated conveying capacity DMF	Calculated conveying capacity based on the calibration value.	
Vibrator running time	The vibrator is switched for this value at the start of every new preparation.	

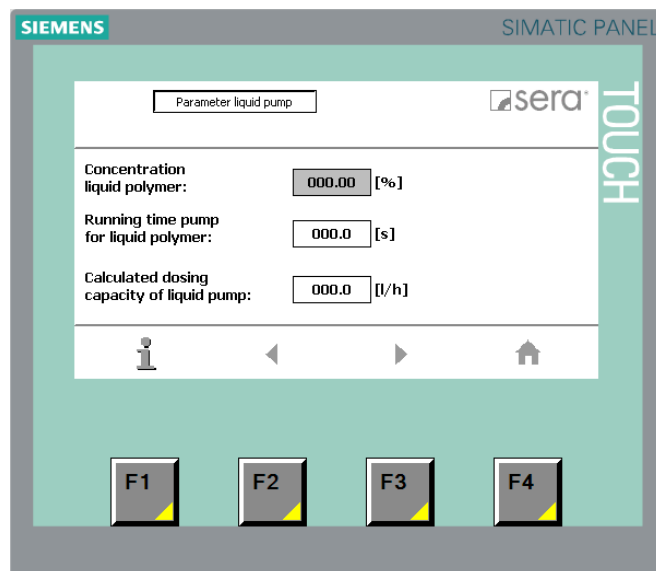

Parameter liquid pump

Parameters	Designation	Value
Concentration liquid polymer	Concentration of the liquid polymer	
Running time pump	Calculated running time pump depending on concentration and calculated capacity.	
Calculated conveying capacity pump	Calculated capacity pump based on calibration value.	

Operating instructions

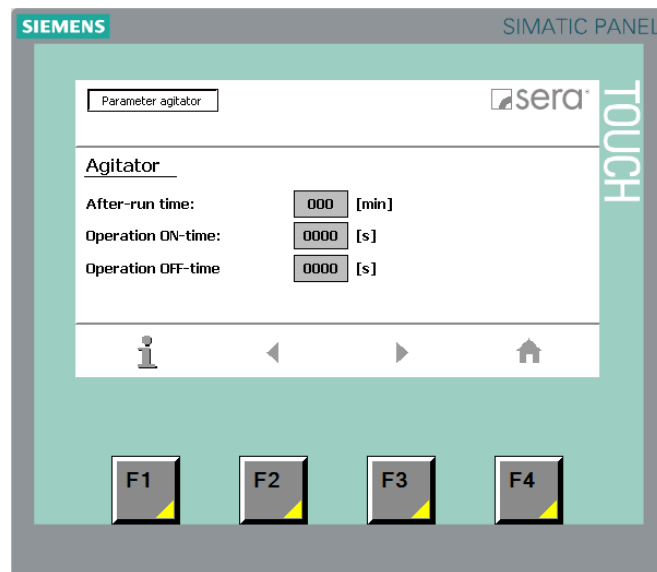

Parameter agitator

Parameters	Description	Value
Agitator overrun time	Overrun time for the agitator after ending the polymer addition.	
Agitator switch-on time	Pulse-pause mode for agitator. - Switch-on time == 0, agitator OFF after ending the preparation - Switch-on time > 0, agitator ON for specified time after ending the preparation	
Agitator pause time	Pulse-pause mode for agitator. - Pause time == 0, agitator always ON after ending the preparation - Pause time > 0, agitator OFF for specified time after ending the preparation	

Operating instructions

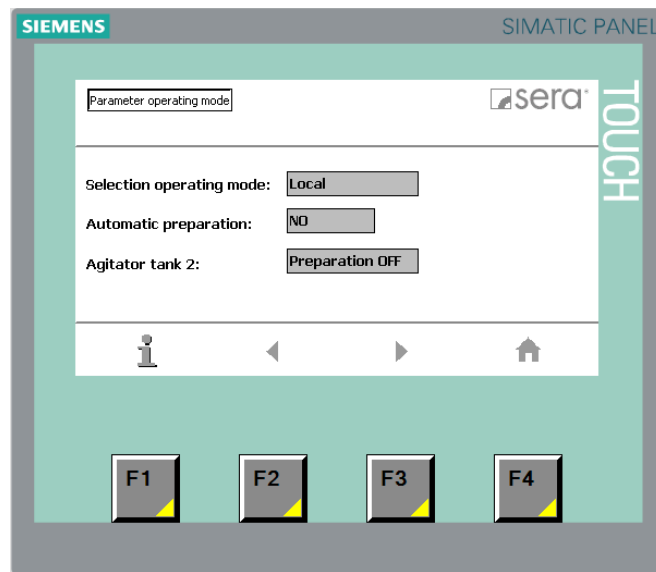

Parameter operating mode

Parameter	Description	Value
Operating mode selection	Selection for the actuation of the automatic preparation - LOCAL - REMOTE (external enable)	
Automatic Solution Preparation	Automatic solution preparation - NO - YES Automatic solution preparation must contain YES for operation of the system. No automatic preparation is started if this contains NO- After changing from YES to NO, the preparation is ended and no new one is started.	
Agitator chamber 2	Operating mode for the agitator in chamber 2 (maturing chamber) - Preparation OFF OFF during the preparation - Preparation ON ON during the preparation	

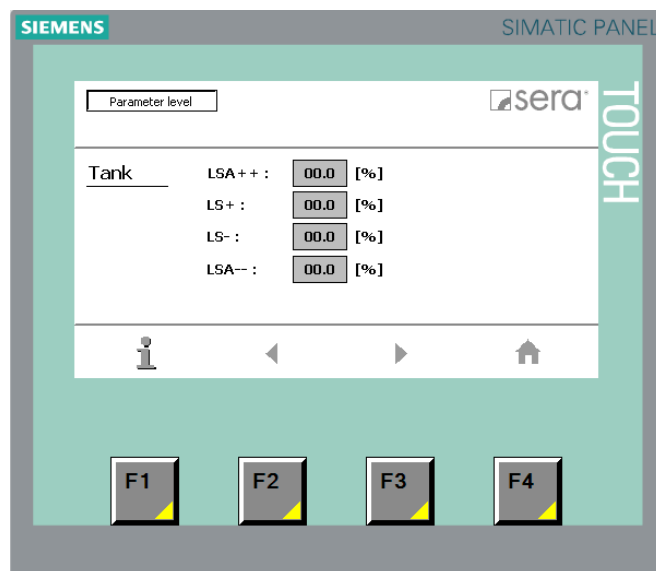

Parameter level

Parameters	Description	Value
LSA++	Setting for the level LSA++ (overflow) of the tank in %. This setting is not necessary for the option - overflow after WHG-	
LS+	Setting for the level LS+ (stop preparation) of the tank in %.	
LS-	Setting for the level LS- (start preparation) of the tank in %.	
LSA--	Setting for the level LSA-- (interlock of downstream pump(s)) of the tank in %.	

Operating instructions

8.4.1 Settings (parameter)

Parameter	Setting range	Factory setting	Customer setting
Parameter preparation			
Inlet volume			
Overrun quantity			
Preparation concentration			
Dosing pulse			
Selection polymer			
Parameter DMF			
Running time DMF (dry material feeder)			
Calculated conveying capacity DMF			
Vibrator running time			
Parameter liquid pump			
Concentration liquid polymer			
Running time pump			
Calculated conveying capacity pump			
Parameter agitator			
Agitator overrun time			
Agitator switch-on time			
Agitator pause time			
Parameter operating mode			
Operating mode selection			
Automatic Solution Preparation			
Agitator chamber 2			
Parameter level			
LSA++			
LS+			
LS-			
LSA--			

Operating instructions

8.5 Service mode

The pages for the service mode are called up on the start screen by pressing the F2 button. The call is password-protected.

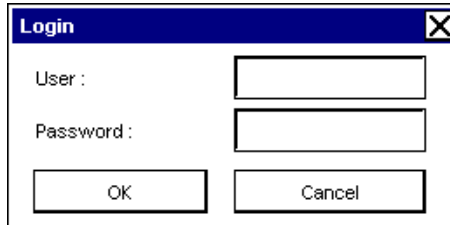

User: USER01
Password: 9990



NOTE!

After logging in correctly, the F2 button must be pressed again.



NOTE!

Automatic mode is switched off when the service pages are called up.



NOTE!

In service mode, all modules can be switched on and off separately.



ATTENTION!

In Service mode the modules are not locked by the filling level.

Operating instructions

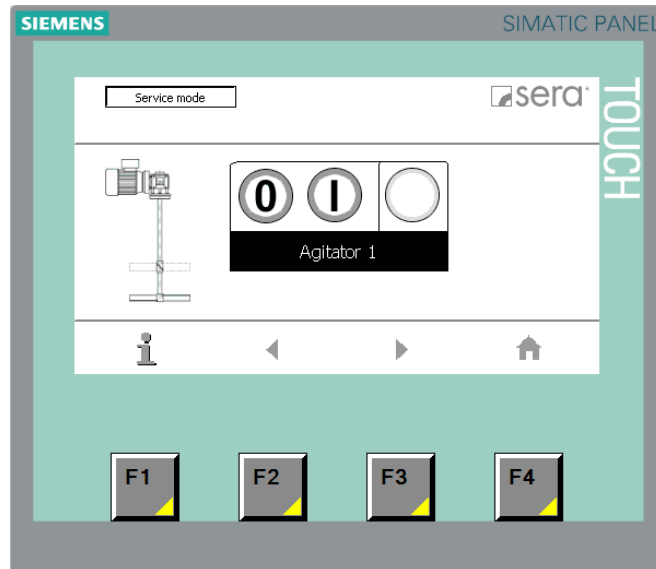

Service mode - Agitator 1

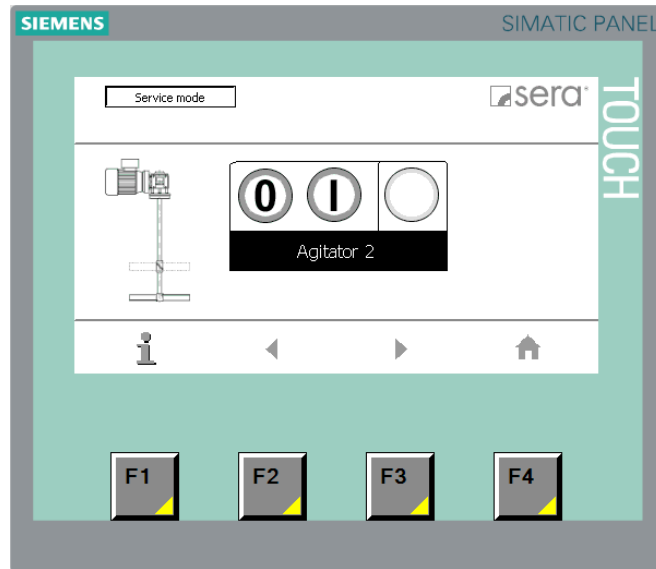

Service mode - Agitator 2

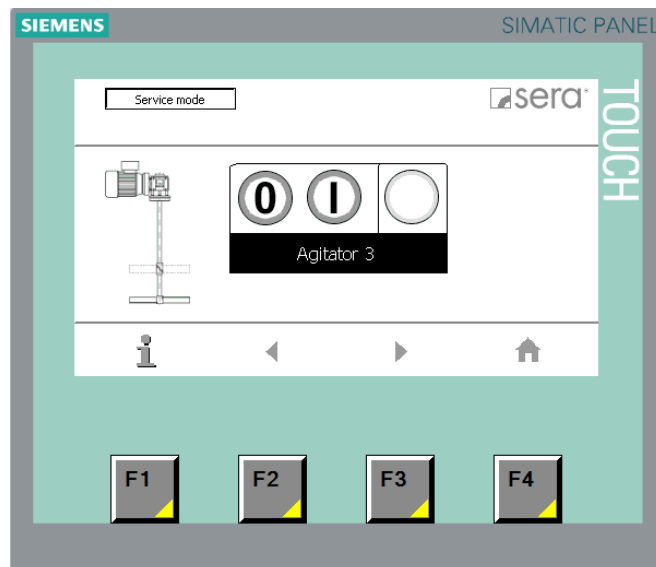

Service mode - Agitator 3 (Optionally)

Operating instructions

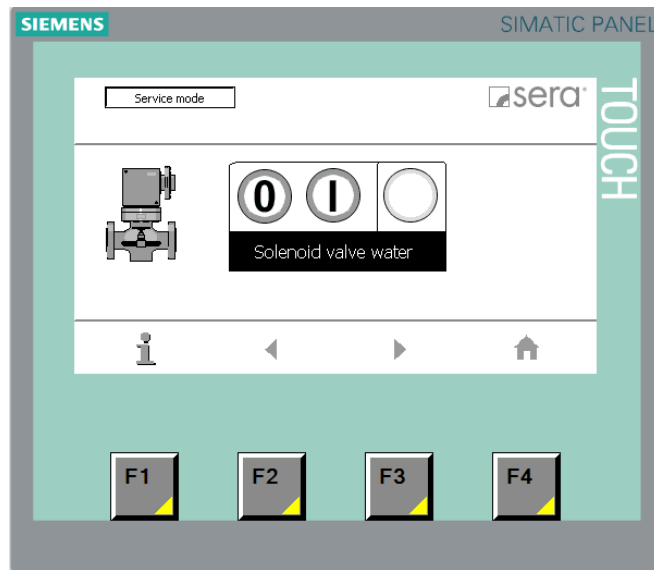

Service mode - Solenoid valve water

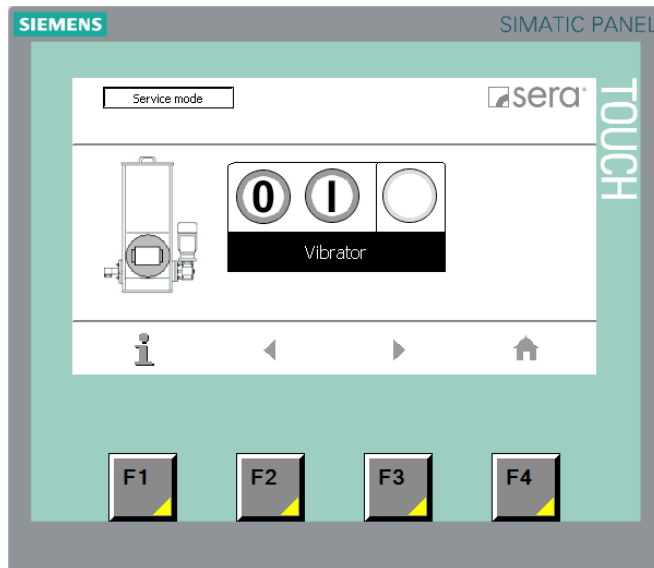

Service mode - Vibrator (Option)

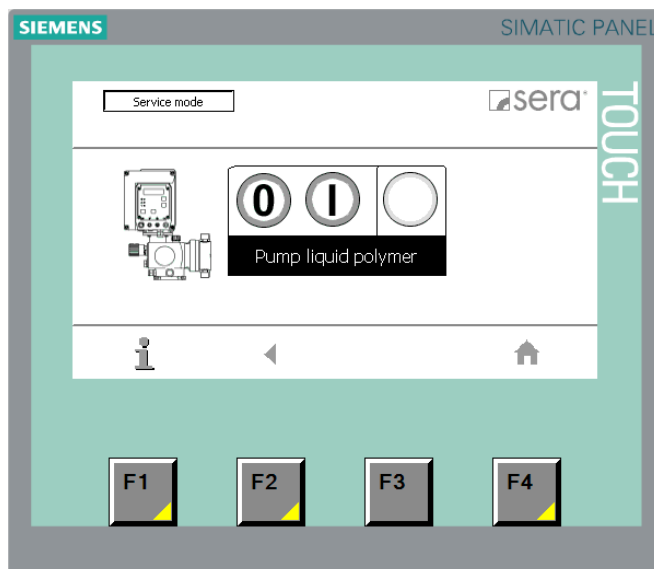

Service mode - Pump for liquid polymer (only by L / SL-Variante!)

Operating instructions

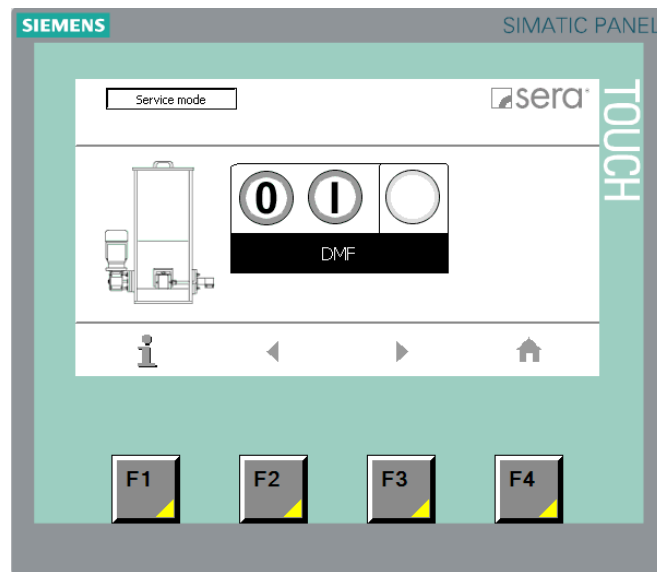

Servicebetrieb - DMF



NOTE!

Service mode DMF only by S / SL - design!

8.6 Setup mode

The pages for the setting up mode are called up on the start screen by pressing the F1 button. Automatic mode is switched off when the setting pages are called up.

Operating instructions

8.6.1 Water flow rate adjustment

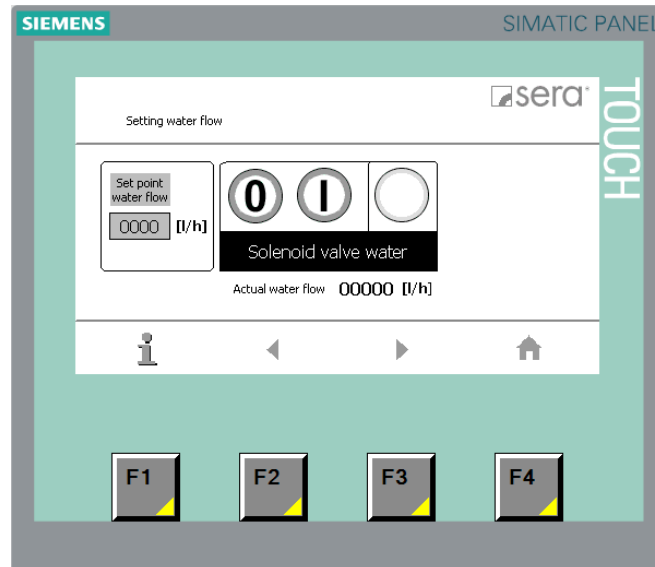

Setting water flow

The setpoint for the flow rate depends on the system capacity. The error signal for "flow rate too low" depends on this value.

Procedure for setting the optimum flow rate:

1. Adjust water pressure at the pressure reducer (approx. 3 bar).
2. Close gate valve.
3. Press "ON" button. Solenoid valve opens.
4. Set optimum water flow rate by adjusting the gate valve on the system capacity.
5. Press "OFF" button. Solenoid valve closes.

8.6.2 Hopper empty signal empty adjustment (option)

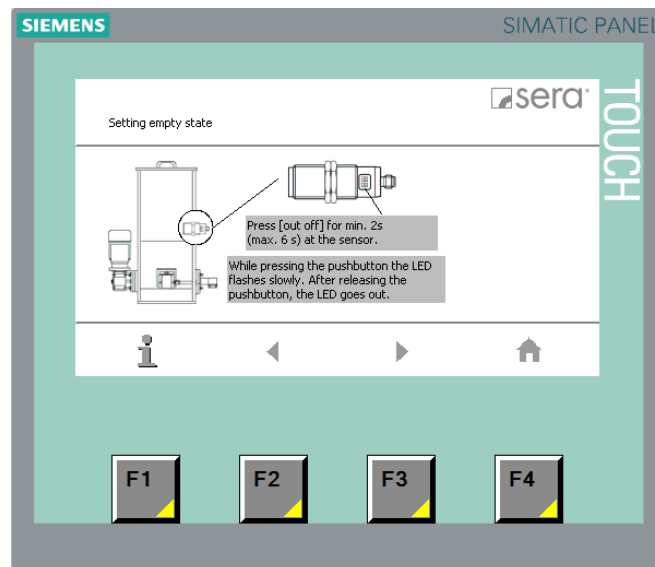

Setting empty state

The empty adjustment of the capacitive sensor is used for adapting to the characteristics of the medium used.

Operating instructions

Procedure for adjustment of the empty adjustment for capacitive sensor for the hopper empty signal:

1. Hopper must be empty, i.e. sensor must not be covered with medium.
2. Perform adjustment according to description (see the control panel).

Due to the empty adjustment (device as normally open contact), the device hides the tank wall. The empty adjustment resets the device. Any already performed adjustment is deleted.

8.6.3 Hopper empty signal full adjustment (option)

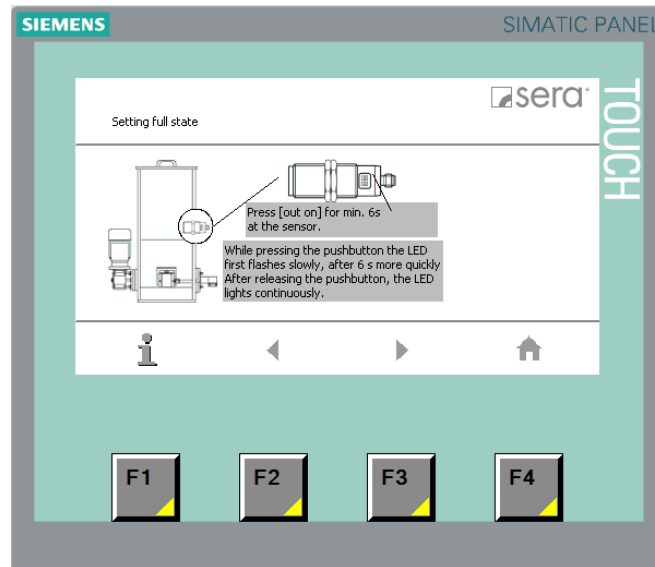

Setting full state

Procedure for adjustment of the full adjustment for capacitive sensor for the hopper empty signal:

1. Fill hopper with medium until the sensor is completely covered.
2. Perform full adjustment according to description (see the control panel).

The full adjustment setting optimises the sensitivity of the sensor. The full adjustment can be repeated later at any time. The already made adaptation of the empty adjustment is maintained.

8.6.4 DMF (dry material feeder) calibration

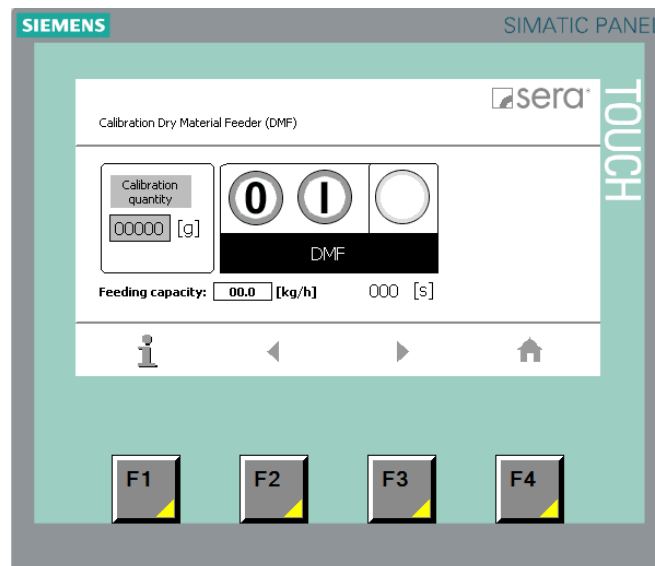

Calibration DMF

Operating instructions

The calibration of the DMF is used for determining the conveying capacity depending on the medium used. The DMF is switched on for 100 s for the calibration process. Afterwards, the collected medium must be weighed and the measured value must be input at the control panel.

DMF calibration process:

1. Remove cover of the induction hopper (see picture below and Chapter 10.1)
2. Place suitable collecting container under DMF discharge pipe (see picture below)
3. Check whether there is sufficient medium in the DMF; if yes continue with step 4.
4. Start calibration by pressing the ON (I) button.
5. After automatic ending of the calibration process, weigh the collected medium
6. Enter the measured value in grams at the control panel.

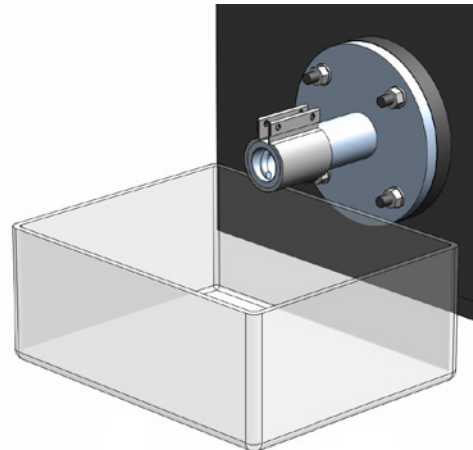
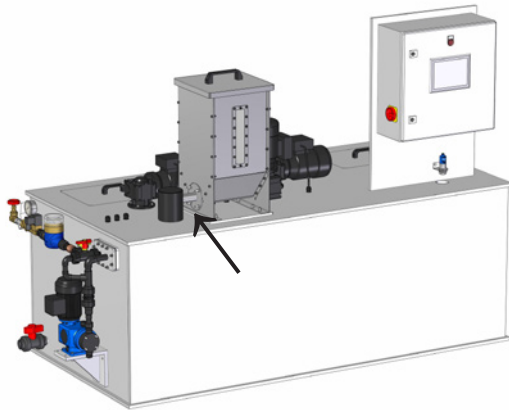

Do not touch rotating parts!

ATTENTION!



Dispose of fallen and scattered medium immediately. There is a very high slipping hazard in the event of contact with water. Wear suitable anti-slip footwear.

ATTENTION!



Calibration pump only by L, SL - design!

NOTE!

Operating instructions

8.6.5 Calibration pump

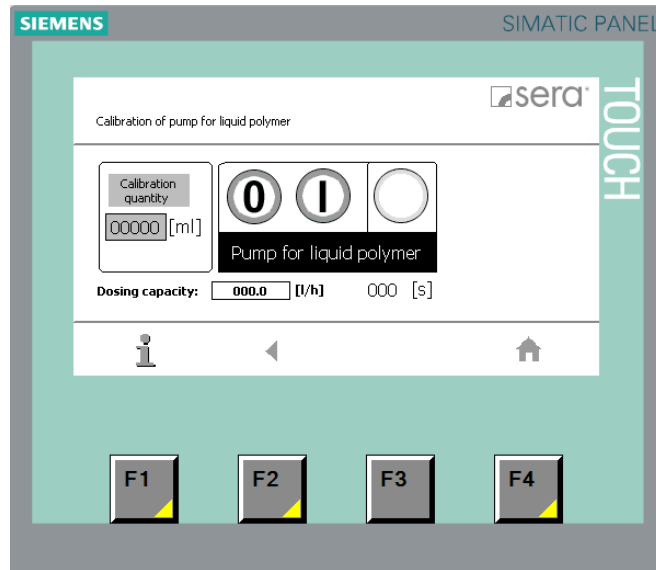

Calibration liquid pump

The calibration of the pump is used for determining the capacity depending of the medium used. The pump is switched on for 100s. Afterwards, the measured value must be input at the control panel.

Pump calibration process:

1. Connect the suction side with a appropriate calibration pot.
2. Fill the calibration pot with liquid polymer.
3. Start the calibration by pressing the ON button.
4. After automatic ending of the calibration process, check and note the pumped medium.
5. Enter the measured value at the control panel.



Calibration pump only by L, SL - design!

NOTE!

8.7 Summation counter

The totaliser pages are called up on the start screen by use the "Σ" button. The reset button is password-protected.

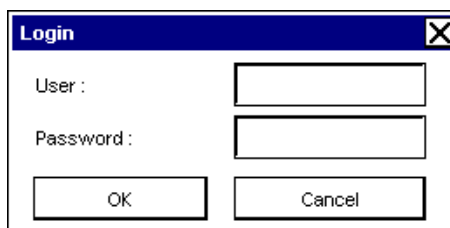

User: USER01
Password: 9990

Operating instructions

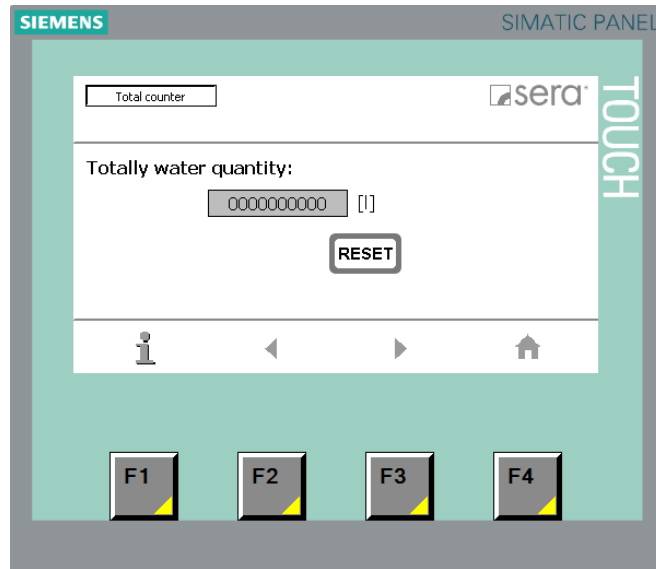

Total counter - Totally water quantity

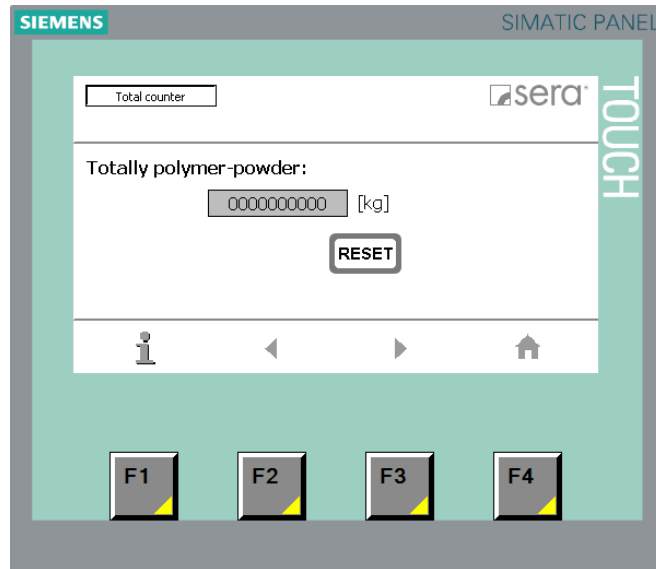

Total counter - Totally polymer-powder

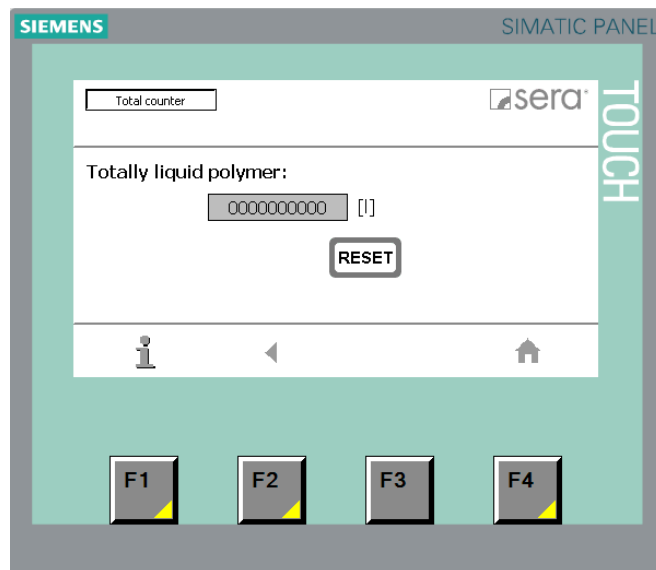

Total counter - Totally liquid polymer

Operating instructions

8.8 System settings

The totaliser pages are called up on the start screen by pressing the F4 button. The button "User" is password-protected.

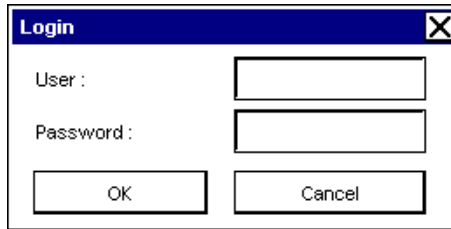

A dialog box titled "Login" with a close button (X) in the top right corner. It contains two input fields: "User:" and "Password:". Below the input fields are two buttons: "OK" and "Cancel".

User: USER01
Password: 9990

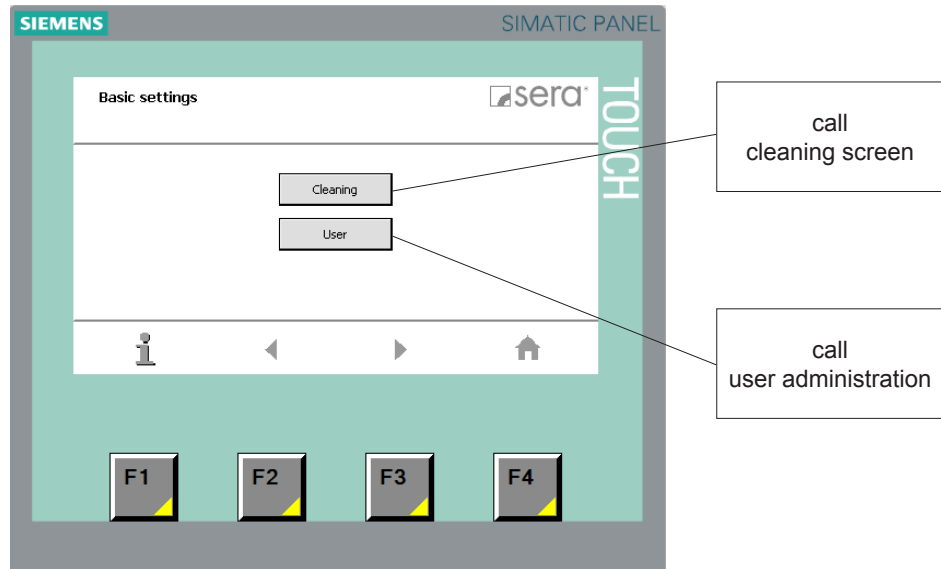

Basic settings

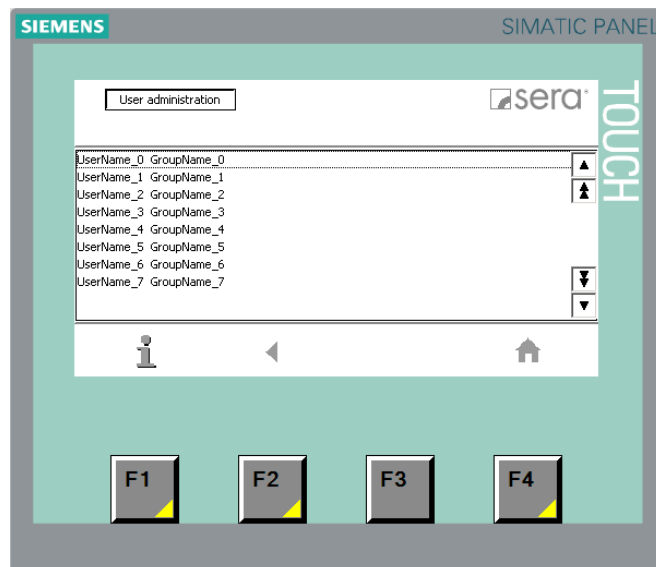

User administration

Operating instructions

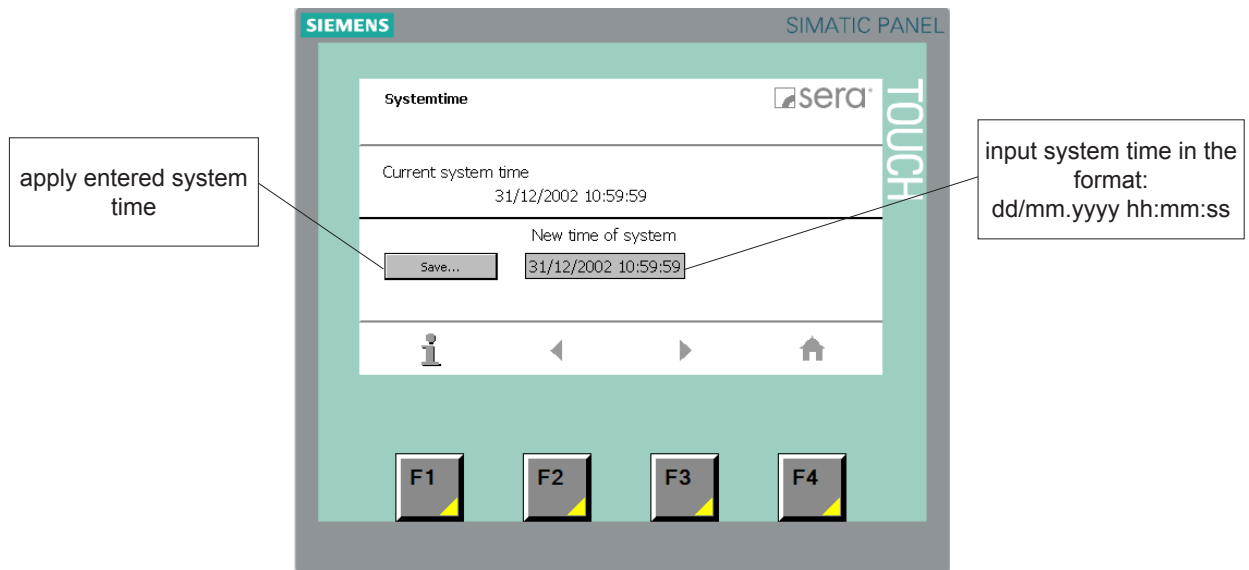

System time

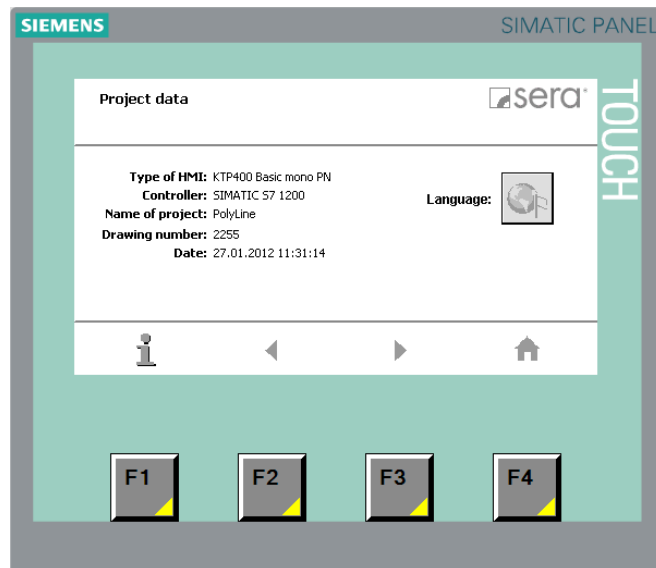

Systeminformation

Operating instructions

8.9 Error messages

Fault messages are displayed as plain text on the control panel and visually with an indicator lamp in the front of the switch cabinet. All fault messages must be acknowledged in the Alarm messages window by pressing the "!" button.

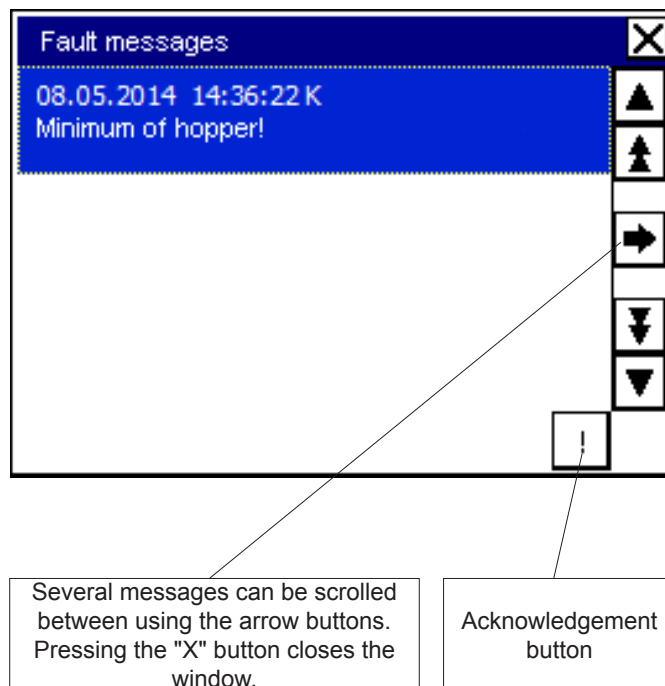
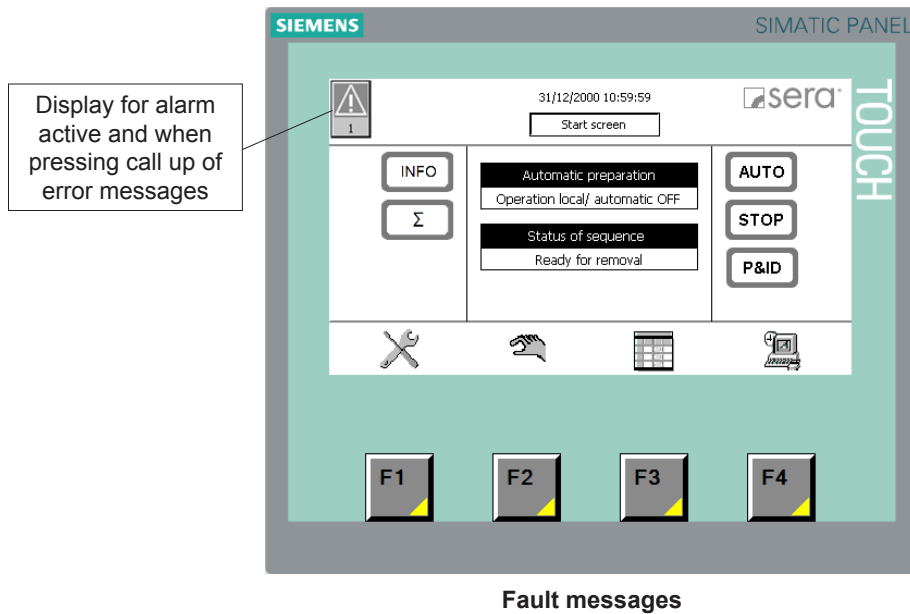

Operating instructions

Message	Cause	Comment
TRIP circuit breaker DMF or agitators!	Current too high, short circuit. Discharge pipe clogged.	Active preparation is interrupted. After rectification of the fault, the preparation continues from the same place.
TRIP circuit breaker solenoid valves or DMF heater!	Current too high, short circuit.	Active preparation is interrupted. After rectification of the fault, the preparation continues from the same place.
Low mean flow of dilution water!	Water flow rate below 85% of the setpoint	Active preparation is interrupted. After rectification of the fault, the preparation continues from the same place.
Tank dry running!	No new preparation is started. Removal too high.	Start new preparation. Reduce removal.
Error signal of sensor level measurement!	Cable break, defective sensor	Active preparation is interrupted. After rectification of the fault, the preparation continues from the same place.
Minimum of hopper!	The hopper of the DMF is empty.	Preparation is ended. No new preparation is started.
TRIP overflow!	Water solenoid valve does not close. Fill level measurement defect	Preparation is ended immediately.
TRIP circuit breaker pump for liquid polymer!	Current too high, short circuit.	Active preparation is interrupted. After rectification of the fault, the preparation continues from the same place.
TRIP circuit breaker vibrator!	Current too high, short circuit.	Preparation continues running.
TRIP circuit breaker conveying system!	Current too high, short circuit.	With the option empty signal for hopper - preparation continues running. Without the option empty signal for hopper - Active preparation is interrupted. After rectification of the fault, the preparation continues from the same place.

8.10 Exchange of signals

For signalling to a higher level control room, the signal of a group fault is wired as potential-free contact on terminal block. The group fault includes the following individual messages:

- DMF (dry material feeder) circuit breaker tripped!
- TRIP circuit breaker solenoid valves or DMF heater!
- Low mean flow of dilution water!
- Tank dry running!
- Error signal of sensor level measurement!
- Minimum of hopper!
- TRIP overflow!
- TRIP circuit breaker pump for liquid polymer!
- TRIP circuit breaker vibrator!
- TRIP circuit breaker conveying system!

Signal output:

Strip terminal	Contact	Description
X7	1, 2, 3	Group fault
X7	4	PE

Operating instructions

Signal output:

Strip terminal	Contact	Description
X8	1	potential-free closing contact
X8	2	



For details see circuit diagram!

NOTE!

9. Commissioning



Start the system only after it was approved by the responsible safety officer!

ATTENTION!



In principle the system is started up with water.

ATTENTION!



It is the owner's task to ensure that the local regulations for prevention of accidents are observed!

ATTENTION!

Carry out the following steps to start the system:

- Before commissioning check all the pipe connections, screwed and flanged connections etc. for proper fit and retighten, if necessary.
- Before switching the system on for the first time, the following points should be checked:
 - Check the electrical connections and the terminal assignment.
 - Check the electrical overcurrent protection devices for correct operation and correct setting.
 - Check whether the local supply voltage and frequency match the information on the rating plates.



Immediately after switching the system, the fault message appears "tank dry running!". Due to the empty removal chamber the fault can not be acknowledged. By exceeding with the filling of the tank the message will disappear. Close the window by pushing the "X" button and proceed with the start up of the unit.

NOTE!

- Carry out the first start-up with water. Pay attention to the water quality according to Chapter "Water quality".
- Switch the system to service mode (button F2).
- Check the rotation direction of the DMF. The screw must turn clockwise when looking at the discharge pipe of the DMF.
- Check the function of the heater on the discharge pipe of the DMF.
- Check the direction of rotation of the agitator. The agitator blade must be clockwise rotating when looking from above.

Operating instructions

- Check the function of the solenoid valve. When the solenoid valve is switched on, the first chamber is filled with water.
- Deactivate service mode (button F4).
- Note and make the settings under point 8.6 "Setting up mode" (water flow rate, DMF)
- Calibration of the pump and DMF.
- Open all shut-off devices that are required for operation. Close the shut-off devices for emptying the pipes.
- A dry run of the electric agitators should be avoided. During the first start up, the preparation chamber must be filled with water until the electric agitators blades are completely submerged. This must be done manually. Please refer to the menu "*Service mode*".
- Close cap of the tank.
- Set and note the required parameters for the preparation (see chap. "Parameters").
- Switch the system into automatic mode. Perform first preparation without polymer (collect polymer); in doing so check function of the fill level measurement and adjust switching points if necessary.



Check whether the setting pressure at the pressure reducer is approx. 3 bar.

ATTENTION!

- The start-up with polymer can now be performed after successful commissioning with water.

Operating instructions

9.1 Function description of wide angle nozzle

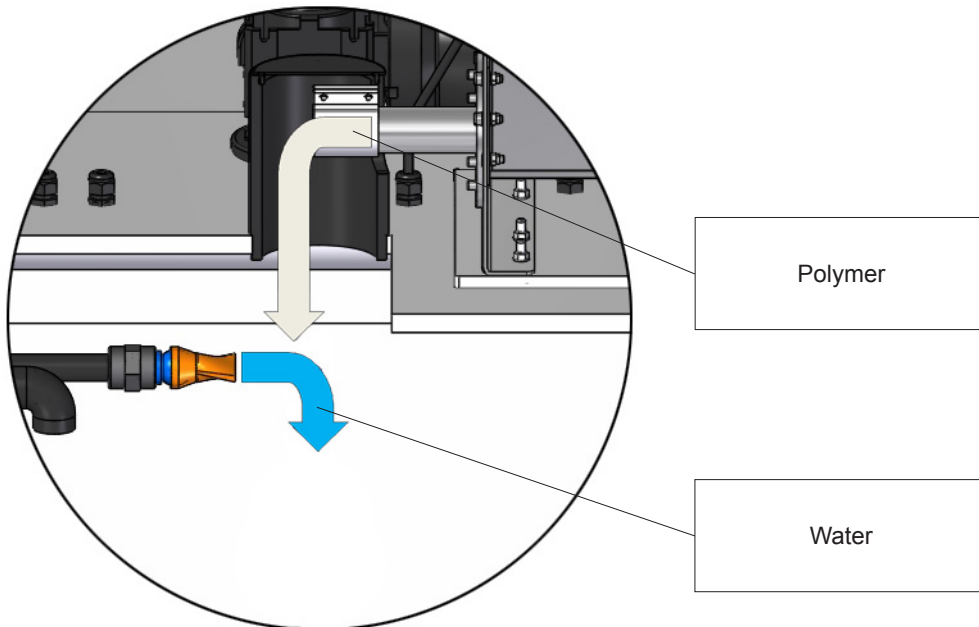
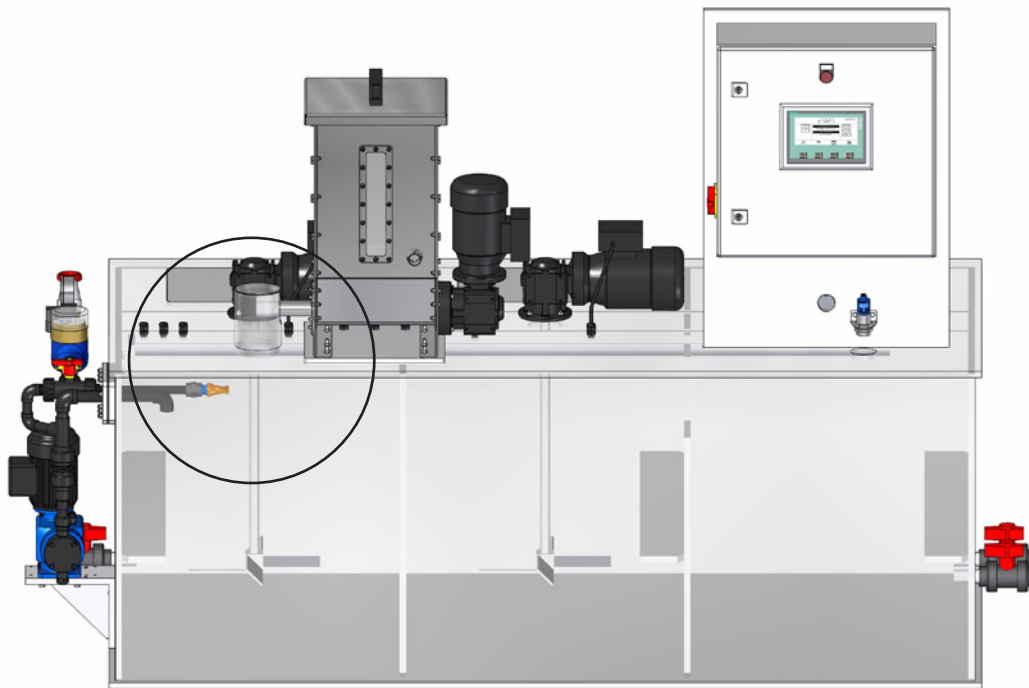
**NOTE!**

The nozzle of the water inlet can be adjusted via a ball joint. Adjust the nozzle so that the polymer will be wetted with water and transported into the mixing chamber. Moisture in the upper part of the dispensing mechanism must be avoided.

Operating instructions

10. Maintenance



WARNING!

Take appropriate protective measures:
Wear protective clothing, breathing protection and safety goggles. Prepare a container with appropriate fluid right beside the pump to be able to remove splashes of the pumped medium



ATTENTION!

Contamination with polymer may cause slippery surfaces. Clean the surfaces with suitable cleaning agents to prevent injury.



ATTENTION!

Depressurise the system before starting maintenance work.



ATTENTION!

Before carrying out maintenance work, repairs, replacement of wear parts, the system must first be rinsed with water (water quality according to Chapter "Water quality") or suitable medium until there are no more chemical residues in the system!
Note compatibility of the rinsing medium with the chemical according to the safety data sheet.

Exothermic reactions must be avoided by all means!



ATTENTION!

Disconnect the system from the power supply and secure against being switched on again by appropriate measures, before starting maintenance and repair work or replacing wearing parts. Contact a qualified electrician for this.



ATTENTION!

Do not use system as a platform!

All maintenance work must be documented carefully. In order to ensure the functionality of the system, technical equipment requires maintenance. The following points for subassemblies or system components must be observed:

Always

- Check the piping for leak tightness; repair if necessary.
- Check screw connections for leak tightness after a longer period of standstill.
- Check the system visually, and check the pressure every six months.
- Check the electrical cables every six months and components at regular intervals for visible damage (loose connections, damaged cables, defective equipment etc.).

Drive motors

- The drive motors are lubricated for life and therefore maintenance-free.

Operating instructions

DMF (SL, S-design)

- Depending on the polymer throughput, check the tank for adhesions and clean if necessary.
- Check for faultless functioning of the mechanical moving parts (metering screw, motor).
- Check the function of the heater on the discharge pipe.



**The discharge pipe of the heater can be hot. Never touch directly!
Allow to cool down long enough for maintenance!**

ATTENTION!

Dispensing mechanism

- Check regularly, but at least once per week, for adhesions and clean if necessary.

Supply unit

- Check all mechanical parts (gate valve, pressure reducer, solenoid valve and flow sensor) for leak tightness.
- Check elements with close function (gate valve and solenoid valve) for leak tightness (when in the closed position).
- Check function of flow sensor.
- Check pressure reducer for correct setting pressure. Clean the strainer.

Tank

- Check regularly for damage and clean in the event of heavy soiling.

Agitators

- Check all fastenings and visual inspection of the shaft and agitator blade via the inspection opening of the tank.

Ultrasonic sensor

- Clean with moist cloth once per year or in the case of heavy soiling / malfunctions.
 - Mark or measure the current screw-in depth (adjustment using both adjustment rings possible)
 - Disconnect sensor connection by detaching the cable (unscrew).
 - Carefully unscrew ultrasonic sensor and clean.
 - Install and connect all components in reverse order.

Pump (SL, L-design)

- Repairs on the stroke mechanism may only be performed by sera!
- Before starting maintenance make sure that the wearing parts and the spare parts required are available. Deposit the parts so that they will not get damaged.
- All wearing parts are to be checked for perfect condition at regular intervals and exchanged if necessary.
- Check oil level regularly (oil eye).
- Check the tight fit of piping and valves.
- Check the tight fit of the screws for fastening the pump body (check this at least every three months). For the tightening torques of the mounting screws, please see the operating instruction of the pump.
- Check the proper condition of the electrical connections.

Other components

- All screw connections and fastenings (e.g. supply unit, agitators etc.) should always be checked for tightness.

Operating instructions

11. Decommissioning

The following points must be observed when you decommission the system:

- Remove remaining polymer from DMF and clean.
- Empty tank and dispose of the contents properly.
- Rinse the pipes with water (water quality according to Chapter "Water quality") or a suitable medium and then empty the pipes.
- Disconnect system from the power supply.
- In the event of longer shutdown, store the system dry with fresh air supply (+5 °C to +40 °C).
- Cover system to prevent ingress of dirt and dust.

12. Restarting

The following points must be observed when you restart the system:

- Check all components for correct seating, leak tightness and stability.
- Clean the complete system.
- Reconnect system connections (water; removal and drain).
- Connect the system to the power supply.

13. Fault analysis and corrective action

sera products are sophisticated technical products which are only shipped after having been thoroughly tested and checked at our factory.

Should there be any faults, these can be detected and rectified easily and quickly according to the following instructions.

Error messages shown on the display of the switch cabinet are shown in Chapter 8.9.

In the event of other problems, check the following list:

Problem	Cause	Comment
Flow rate too high / too low	gate valve opened too much / not enough	Turn both gate valves to adjust until required flow rate is reached.
Flow rate too high / too low	Incorrect pressure at the pressure reducer	Check setting pressure at the pressure reducer and adjust if required.
Flow too low	Too low feed by supply line	Enlarge line, open gate valve further.
Water continues running despite stopped preparation process	Defective seal in solenoid valve	Replace solenoid valve.
Mixing unit does not operate correctly	Mixing unit not adjusted to operating conditions.	Adjust mixing unit using the adjustment ring (see chapter 9.1).
Mixing unit does not operate correctly	Too thick deposits at the edge	Clean mixing unit. Shorten maintenance interval.
Tanks cannot be drained	Drain valves clogged	Clean the tanks and gate valves.

14. Disposal

Shut down the system. See "Decommissioning".

Operating instructions

14.1 Removal and transport

- Remove all fluid residues, clean thoroughly, neutralise and decontaminate.
- Rinse the pipes with water (water quality see Chapter "Water quality") or a suitable medium and drain afterwards.
- Package the dosing system appropriately and ship.
- If the system is shipped for repair the gearing must be filled with oil.



Transport the system in a horizontal position!

ATTENTION!



Close the pipe openings for transport!

ATTENTION!

14.2 Complete disposal

- Remove all fluid residues (incl. consumables) from the unit.
- Drain lubricants and hydraulic fluids and dispose of according to the regulations!
- Rinse the pipes with water (water quality see Chapter "Water quality") or a suitable medium and drain the pipes afterwards.



Be aware of the Material safety data sheets (MSDS) of all operating materials!

ATTENTION!



The consignor is responsible for damage caused by leaking lubricants and fluids!

ATTENTION!

15. Documentation of the system parts

In addition to these operating instructions the operating instructions and the data sheets contained in the complete documentation must be observed:

- Operating manual of the dry material feeder
- Operating manual of the electric agitator
- Data sheet of the flow sensor
- Data sheet of the ball valve
- Data sheet of the solenoid valve
- Data sheet of the pressure reducer
- Data sheet of the gate valve
- Data sheet of the check valve
- Data sheet of the manometer

Operating instructions

16. Clearance Certificate



NOTE!

Inspection / repair of machines and machine parts is only carried out after the adjacent clearance certificate filled in correctly and completely by authorised and qualified specialist personnel is available.

The Germany legal provisions for occupational health and safety, e.g. the workplaces ordinance (ArbStättV), the Ordinance on Hazardous Substances (GefStoffV), the accident prevention regulations and the environmental protection regulations such as the Waste Management Law (AbfG) and the Water Resources Law (WHG) obligate all industrial companies to protect their employees or people and the environment from detrimental effects when handling hazardous substances.

Should special safety precautions be necessary despite careful draining and cleaning of the product the necessary information must be provided.

Machines which have been operated with radioactive media shall only be inspected and/or repaired in the safety zone of the owner by a sera specialist.

The clearance certificate is part of the inspection / repair order.
sera reserves the right to refuse acceptance of the order for other reasons.



































NOTE!

Make a copy and leave the original with the operating manual
(can also be downloaded from: www.sera-web.com)

Operating instructions

Clearance Certificate

Product	
Type <input style="width: 90%;" type="text"/>	Serial-No. <input style="width: 90%;" type="text"/>
the product was carefully emptied before shipping / delivery, and cleaned inside and outside. <input type="checkbox"/> YES	

Conveying medium													
Designation <input style="width: 90%;" type="text"/>	Concentration <input style="width: 90%;" type="text"/> %												
Properties Please tick! If either of the listed properties, then enclose the appropriate safety and handling instructions.	<table style="width: 100%; text-align: center;"> <tr> <td><input type="checkbox"/>  Harmless</td> <td><input type="checkbox"/>  Toxic</td> <td><input type="checkbox"/>  Corrosive</td> <td><input type="checkbox"/>  Flammable</td> <td><input type="checkbox"/>  Oxidising</td> <td><input type="checkbox"/>  Unhealthy</td> </tr> <tr> <td><input type="checkbox"/>  Explosive</td> <td><input type="checkbox"/>  Dangerous for the environment</td> <td><input type="checkbox"/>  Irritant</td> <td><input type="checkbox"/>  Bio-hazardous</td> <td><input type="checkbox"/>  Radioactive</td> <td></td> </tr> </table>	<input type="checkbox"/>  Harmless	<input type="checkbox"/>  Toxic	<input type="checkbox"/>  Corrosive	<input type="checkbox"/>  Flammable	<input type="checkbox"/>  Oxidising	<input type="checkbox"/>  Unhealthy	<input type="checkbox"/>  Explosive	<input type="checkbox"/>  Dangerous for the environment	<input type="checkbox"/>  Irritant	<input type="checkbox"/>  Bio-hazardous	<input type="checkbox"/>  Radioactive	
<input type="checkbox"/>  Harmless	<input type="checkbox"/>  Toxic	<input type="checkbox"/>  Corrosive	<input type="checkbox"/>  Flammable	<input type="checkbox"/>  Oxidising	<input type="checkbox"/>  Unhealthy								
<input type="checkbox"/>  Explosive	<input type="checkbox"/>  Dangerous for the environment	<input type="checkbox"/>  Irritant	<input type="checkbox"/>  Bio-hazardous	<input type="checkbox"/>  Radioactive									
The product was used with health or water-polluting substances and came up with labeling requirements and pollution prone media in contact. <input type="checkbox"/> YES <input type="checkbox"/> NO													
Special security arrangements with respect to health or water-hazardous media are in the further handling <input type="checkbox"/> not required <input type="checkbox"/> required													
The following safety precautions regarding rinsing, residual liquids and waste disposal are required: <div style="border: 1px solid black; height: 50px; width: 100%;"></div>													

Process data	
The product was used with the following operating conditions described conveying medium:	
Temperature <input style="width: 90%;" type="text"/> °C	Pressure <input style="width: 90%;" type="text"/> bar

Sender		
Company: _____	Telephone: _____	
Contact person: _____	FAX: _____	
Address: _____	E-mail: _____	
Zip code, City: _____	Your order No: _____	
<p>We confirm that we have the information in this safety certificate (Clearance Certificate) have been correctly and completely and that the returned parts were carefully cleaned.</p> <p>The parts are sent free of residues of dangerous amount.</p>		
_____ Place, Date	_____ Department	_____ Signature (and company stamp)

Operating instructions

NOTES

