

Operating instructions

Typ:

- 791.1
- 792.1
- 793.1
- 794.1
- 795.1
- 796.1
- 797.1



Manufacturer:

**sera GmbH**  
 sera-Straße 1  
 34376 Immenhausen  
 Germany  
 Tel.: +49 5673 999-00  
 Fax: +49 5673 999-01

[info@sera-web.com](mailto:info@sera-web.com)  
[www.sera-web.com](http://www.sera-web.com)

<b>Keep the operating instructions for future use!</b>	
Please state here the exact type of your calibration pot. (can be read off the product description on the calibration pot)	
<b>Type</b>	:
These data are important in case of queries or for ordering spare parts and must absolutely be stated.	

Translation of the original operating instructions!



## Operating instructions

### Content

<b>1. General</b> .....	<b>4</b>
1.1 General user information.....	4
1.2 Symbols and notes used in these operating instructions .....	4
1.3 Quality instructions .....	5
<b>2. Safety instructions</b> .....	<b>5</b>
2.1 Personnel qualification and training .....	5
2.2 Dangers in case of inobservance of the safety instructions .....	5
2.3 Safety conscious working.....	5
2.4 Safety instructions for owner / operator .....	5
2.5 Safety instructions for maintenance, servicing and installation work .....	6
2.6 Arbitrary modification and production of spare parts .....	6
2.7 Improper operations .....	6
2.8 Intended use .....	6
2.9 Personal protection for maintenance and service .....	6
<b>3. Transport and storage</b> .....	<b>7</b>
3.1 General .....	7
3.2 Storage.....	7
<b>4. Product description</b> .....	<b>8</b>
4.1 Type plate .....	8
4.2 Temperature range .....	8
4.3 Accessories .....	9
<b>5. Technical data</b> .....	<b>10</b>
5.1 Dimensions .....	10
<b>6. Installation</b> .....	<b>11</b>
<b>7. Start-up</b> .....	<b>12</b>
<b>8. Decommissioning</b> .....	<b>13</b>
<b>9. Disposal</b> .....	<b>13</b>
9.1 Dismantling and transport .....	13
9.2 Complete disposal.....	13
<b>10. Clearance certificate</b> .....	<b>14</b>

## Operating instructions

### 1. General





#### 1.1 General user information

The regulations applicable to the place of installation are to be observed before the commissioning and during the operation of the product from **sera**.

Always read these instructions and particularly the safety instructions before installation and commissioning of the **sera** product.

#### 1.2 Symbols and notes used in these operating instructions

Special notes in these operating instructions are marked with text and danger symbols.

Notes (Text and symbol)	Danger type			Meaning (in the operating instructions)
	Danger to life	Risk of injury	Dam. to property	
<b>DANGER!</b> 	X	X	X	Identifies <b>imminent danger</b> that could lead to death or serious injury if not avoided.
<b>WARNING!</b> 	X	X	X	Indicates a potentially dangerous situation that could lead to death or serious injury and damage to property if not avoided.
<b>CAUTION!</b> 		X	X	Indicates a potentially dangerous situation that could lead to slight or minor injury or damage to property if not avoided.
<b>ATTENTION!</b> 			X	Indicates a potentially dangerous situation that could lead to damage to property if not avoided.
<b>NOTE!</b> 				Indicates information which help to facilitate the work and is useful for a trouble-free operation.

## Operating instructions

### 1.3 Quality instructions

Observance of these operating instructions and, in particular, the safety instructions, helps to

- avoid dangers to persons, machines and environment,
- increase reliability and service life of the product and the complete system,
- reduce repair cost and downtime.

The **sera** quality management and quality assurance system for pumps, systems, valves and fittings and compressors is certified according to ISO 9001:2008.

The **sera** products meet the valid safety and accident prevention regulations.



**ATTENTION!**

**Always keep these operating instructions within reach at the place of installation.**



**WARNING!**

**Pay attention to the safety data sheet of the medium! The owner must take corresponding accident prevention measures to protect operating personnel from danger through the delivery media used!**

## 2. Safety instructions

### 2.1 Personnel qualification and training

The personnel for operation, maintenance, inspection and installation must be suitably qualified for their tasks. The owner must clearly define responsibility and supervision of the personnel.

If the personnel do not have the knowledge required, then personnel is to be trained and instructed correspondingly. Such training can be provided by the manufacturer / supplier upon order of the owner. In addition, the owner has to ensure that personnel have understood the operating instructions completely.

### 2.2 Dangers in case of inobservance of the safety instructions

Inobservance of these safety instructions can result in danger to persons, hazards to the environment and damage to the product.

Inobservance of the safety instructions may lead to:

- Failure of important functions of the product/system.
- Inobservance of prescribed methods for maintenance and servicing.
- Danger to persons through chemical influences.
- Hazards to the environment through leaking dangerous media.

### 2.3 Safety conscious working

The safety instructions specified in this operating manual, the national regulations for accident prevention, the safety regulations for the pumped medium valid at the place of installation as well as internal working-, operating-, and safety instructions of the owner are to be observed.

### 2.4 Safety instructions for owner / operator

Leaking hazardous delivery media supplies are to be disposed off in such a way that any danger to persons and the environment is excluded. The legal regulations are to be observed.

## Operating instructions

### 2.5 Safety instructions for maintenance, servicing and installation work

The owner must ensure that any maintenance-, servicing- and installation work is only entrusted to authorized and suitably qualified personnel who have carefully read and understood the operating instructions.

Only those spare parts are to be used which meet the requirements of the specified operating conditions.

Threaded joints and connections may only be disconnected when the system is not under pressure.

### 2.6 Arbitrary modification and production of spare parts

Modifications of or changes to the product are only permitted after previous agreement of the manufacturer. Original spare parts and accessories which were approved by the manufacturer are essential for safety reasons.



**CAUTION!**

**If the product is modified without authorization of the manufacturer or spare parts are used which are not approved, any warranty claim becomes null and void.**

### 2.7 Improper operations

Operating safety of the supplied product is only guaranteed if the product is used as intended, according to the descriptions in Chapter „Intended use“ of these operating instructions.

### 2.8 Intended use

The **sera** product is only to be deployed according to the intended purpose stated in the product description. If the product is to be used for other applications, then the suitability of the suction lance for the new operating conditions must be discussed with **sera** beforehand!

Criteria for operation of the product in accordance with the intended use:

- Observe characteristics of the medium (please see safety- and product data sheet of the delivery medium – the safety data sheet is to be provided by the supplier / owner of the pumped medium).
- Resistance of the materials which come into contact with the pumped medium.
- Operating conditions at the place of installation.
- Temperature of the pumped medium.
- Max. pressure of the product.

### 2.9 Personal protection for maintenance and service

National safety regulations for the pumped medium must strictly be adhered to.

In case of accidents check whether the following substances are emitted:

- Leaking fluids.
- Leaking vapours.

Emissions are to be monitored by corresponding control systems of the total installation.

Operating instructions



**Wear protective clothing, gloves, breathing mask and a face protecting mask.**





**ATTENTION!**



**Personal protective equipment must be provided by the owner!**

**NOTE!**









**NOTE!**

**3. Transport and storage**

**3.1 General**

**sera** - products are checked for perfect condition and function previous to shipment. Check for transport damage immediately after arrival of goods. If damage is found, this is to be reported immediately to the responsible carrier and the manufacturer.



**The packaging material must be disposed of appropriately!**

**NOTE!**

**3.2 Storage**

An undamaged packaging protects the unit during storage and should only be opened when the product is installed.

Proper storage increases the service life of the product and includes prevention of negative influences such as heat, moisture, dust, chemicals etc.

The following storage specifications are to be observed:

- Storage place: cool, dry, dustfree and slightly ventilated
- Storage temperature between +2°C and +40°C
- Relative air humidity not more than 50 %.
- The maximum storage time is 12 months.

Do not store solvents, fuels, lubricants, chemicals, acids, disinfectants and similar in the storage room.

## Operating instructions

### 4. Product description

sera calibration pot serves to determine the liquid flow of dosing pumps under real working conditions.

1	Ventilating joint
2	Fixing clamps
3	Graduation
4	Filling and removal joint

Graduation	
Volume per graduation mark	
Pipe Ø 50	► 10cm <sup>3</sup>
Pipe Ø 110	► 100cm <sup>3</sup>
Pipe Ø 160	► 500cm <sup>3</sup>

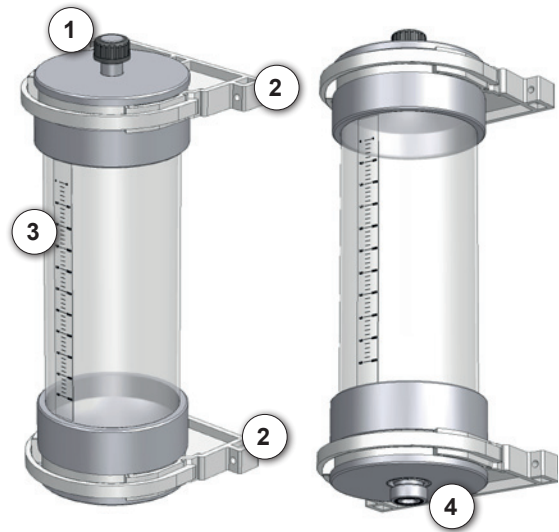

### 4.1 Type plate

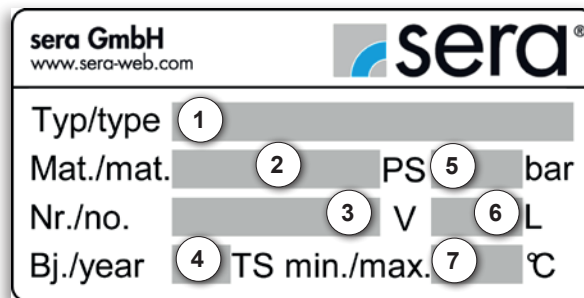

No.	Designation
1	Type designation
2	Material of casing / seal
3	Serial number
4	Year of manufacture
5	Pressure range [bar]
6	Volume [litre]
7	Temperature range [°C]

### 4.2 Temperature range

The temperature range of the siphon vessels / priming aids is between 0°C und +40°C (in relation to water).

The temperature range changes depending on the medium ► this must be checked by the owner.



Operating instructions

**4.3 Accessories**

Venting elbow									
Image	Material	Conne- tion	Item-No.						
			791.1	792.1	793.1	794.1	795.1	796.1	797.1
	PVC-U	G 3/4	90010968	90010969	---	---	---	---	---
		G 1	---	---	90010970	90010971	90010972	90010973	90010974

Operating instructions

**5. Technical data**

Type	Nominal width DN	Max. admissible operating pressure bar	Content l	Empty weight kg	Material		Item-No.
					Housing	Seal	
791.1	8	-0,5...+2	0,1	0,25	PVC-U / PVC-transp.	EPDM	30097002
						FPM	30097009
792.1	8	-0,5...+2	0,5	0,4		EPDM	30097003
						FPM	30097010
793.1	10	-0,5...+2	1	1,75		EPDM	30097004
						FPM	30097011
794.1	15	-0,5...+2	2	1,9		EPDM	30097005
						FPM	30097012
795.1	20	-0,5...+2	5	4,4		EPDM	30097006
						FPM	30097013
796.1	40	-0,5...+2	10	5,4		EPDM	30097007
						FPM	30097014
797.1	40	-0,5...+2	20	6,75		EPDM	30097008
						FPM	30097015

**5.1 Dimensions**

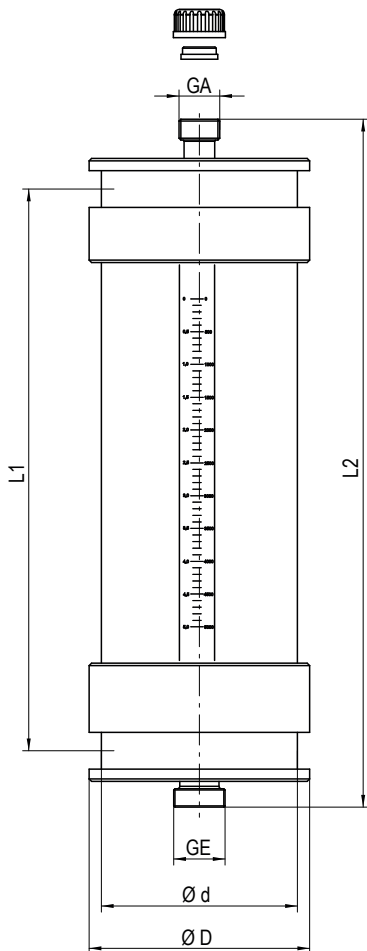

Type	GE	GA	d	D	L1	L2
791.1	G 3/4	G 3/4	50	53	157	220
792.1	G 3/4	G 3/4	50	53	574	637
793.1	G 3/4	G 1	110	120	282	387
794.1	G 1	G 1	110	120	455	570
795.1	G 1 1/4	G 1	160	180	458	562
796.1	G 2 1/4	G 1	160	180	728	850
797.1	G 2 1/4	G 1	160	180	1269	1391

## Operating instructions

### 6. Installation

The calibration pot is mounted into suction side of a dosing pump.



**ATTENTION!**

The installation is exclusively carried out by authorized personnel!



**NOTE!**

If possible, connect ventilating joint with the related dosing tank.

### Example of installation

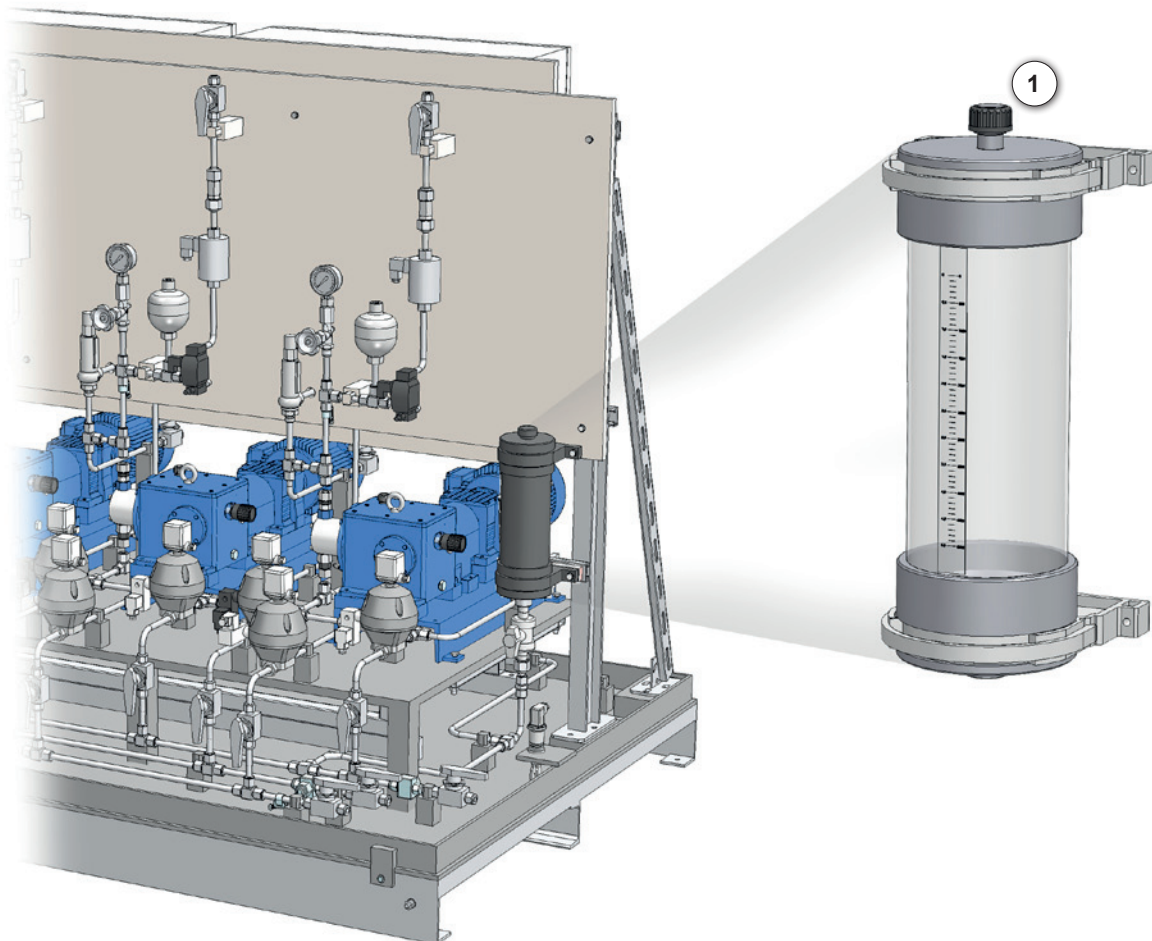

## Operating instructions

### 7. Start-up

The calibration pot can be filled either according to the principle of interconnected tanks or with the help of a dosing pump (depending on the plant construction).

During the filling respectively calibration process the ventilating joint (1) must be opened. After filling / calibration the ventilating joint must be closed immediately.



**CAUTION!**

**Don't overfill calibration pot (max. up to nominal contents) as otherwise medium can leak from ventilating joint (resp. venting elbow)!**

### Calibration procedure

- Use the supply container (4) to fill the calibration pot (2), with the shut-off valves (3) in their respective positions.
- Position the shut-off valves to ensure that the dosing pump (5) is fed only by the calibration pot.
- Operate the dosing pump for a relevant amount of time.
- Take an output reading from the calibration pot.
- Determine the liquid flow and correct it at the stroke adjustment nut (6) of the pump, if necessary.
- Repeat the process.
- Bring the ball valves back to their correct positions.

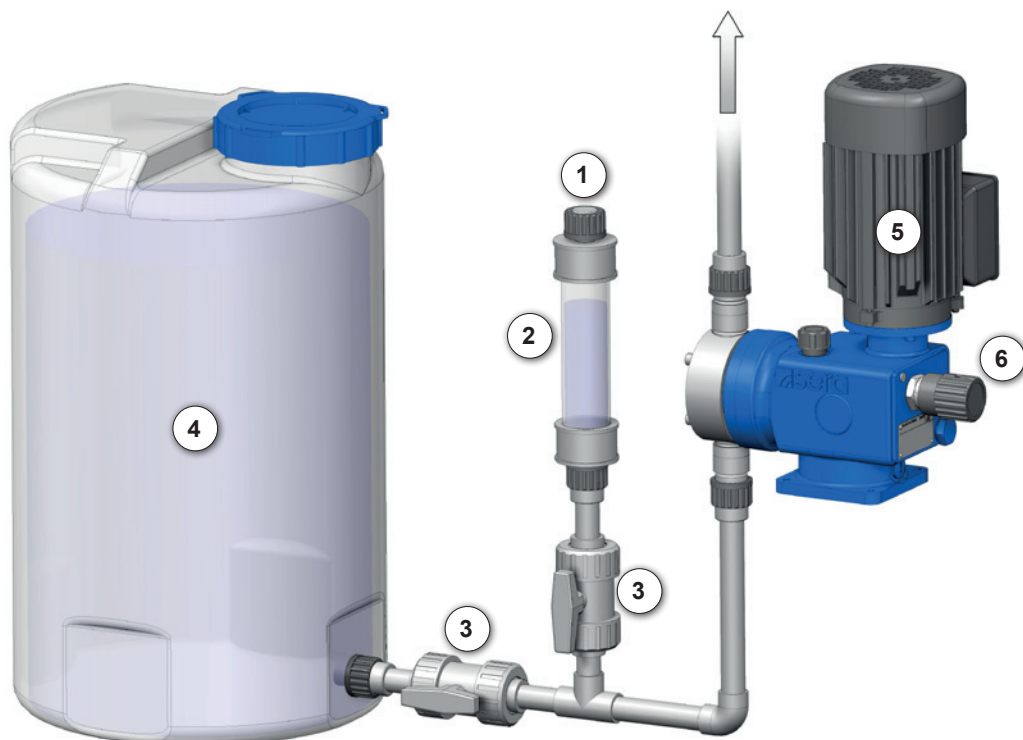

## Operating instructions

### 8. Decommissioning

The following points must be observed when you decommission:

- Switch off the unit.
- Disconnect the unit from the power supply.
- Empty the product.



**DANGER!**

After the chemical was drained, rinse the unit / product with water or a suitable medium until there are no more chemical residues!  
Note the compatibility of the rinsing medium with the chemical according to the safety data sheet.

Exothermic reactions must be avoided by all means!

### 9. Disposal

- Shut-down the product. Please see "Decommissioning".

#### 9.1 Dismantling and transport

- Package the suction lance and ship.



**NOTE!**

A clearance certificate must be filled in when systems are returned to the manufacturer (see Chapter „Clearance certificate“).

Acceptance will be rejected if this clearance certificate is not attached.



**WARNING!**

The consignor is responsible for leaking fluids!

#### 9.2 Complete disposal

- Remove all fluid residues.
- Dismount materials and send them to a suitable waste disposal company!



**WARNING!**

The consignor is responsible for leaking fluids!

## Operating instructions

### 10. Clearance certificate



#### NOTE!

Inspection / repair of machines and machine parts is only carried out after the opposite clearance certificate was filled in correctly and completely by authorized and qualified personnel.



#### NOTE!

Acceptance will be refused if parts are returned to the manufacturer without a proper clearance certificate.

All industrial companies are obligated by the legal provisions for occupational health, e.g. the workplaces ordinances, the Ordinance on Hazardous Substances, the regulations for prevention of accidents and the environmental protection regulations such as the Waste Management Act and the German Household Water Act to protect their employees or man and the environment from detrimental effects when handling hazardous substances.

Should special safety precautions be necessary despite careful draining and cleaning of the product the necessary information are to be provided.

Machines which are operated with radioactive media shall only be inspected and/or repaired in the safety area of the owner by a sera specialized fitter.

The clearance certificate is part of the inspection-/repair order.  
sera reserves the right to refuse acceptance of the order for other reasons.



#### NOTE!

**Please make a copy and leave the original with the operating instructions!**  
(can also be downloaded from: [www.sera-web.com](http://www.sera-web.com))

Operating instructions

**Clearance Certificate**

**Product**

Type

Serial-No.

the product was carefully emptied before shipping / delivery, and cleaned inside and outside.

YES

**Conveying medium**

Designation

Concentration

 %

**Properties**

Please tick!



Harmless



Toxic



Corrosive



Flammable



Oxidising



Unhealthy



Explosive



Dangerous for the environment



Irritant



Bio-hazardous



Radioactive

If either of the listed properties, then enclose the appropriate safety and handling instructions.

The product was used with health or water-polluting substances and came up with labeling requirements and pollution prone media in contact.

YES

NO

Special security arrangements with respect to health or water-hazardous media are in the further handling

not required

required

The following safety precautions regarding rinsing, residual liquids and waste disposal are required:

**Process data**

The product was used with the following operating conditions described conveying medium:

Temperature

 °C

Pressure

 bar

**Sender**

Company: \_\_\_\_\_

Telephone: \_\_\_\_\_

Contact person: \_\_\_\_\_

FAX: \_\_\_\_\_

Address: \_\_\_\_\_

E-mail: \_\_\_\_\_

Zip code, City: \_\_\_\_\_

Your order No: \_\_\_\_\_

**We confirm that we have the information in this safety certificate (Clearance Certificate) have been correctly and completely and that the returned parts were carefully cleaned.**

**The parts are sent free of residues of dangerous amount.**

\_\_\_\_\_  
Place, Date

\_\_\_\_\_  
Department

\_\_\_\_\_  
Signature  
(and company stamp)

NOTES



NOTES

