

Type: S-03



Manufacturer:

sera GmbH
sera-Straße 1
34376 Immenhausen
Germany
Tel.: +49 5673 999-00
Fax: +49 5673 999-01

info@sera-web.com
www.sera-web.com

Keep the operating instructions for future use!

Please state here the exact type of your suction lance.
(can be read off the product description on the suction lance)

Type :

These data are important in case of queries or for ordering spare parts and must absolutely be stated.

Translation of the original operating instructions!

Operating instructions

Content

1. General	4
1.1 General user information.....	4
1.2 Symbols and notes used in these operating instructions	4
1.3 Quality instructions	5
2. Safety instructions	5
2.1 Personnel qualification and training	5
2.2 Dangers in case of inobservance of the safety instructions	5
2.3 Safety conscious working.....	5
2.4 Safety instructions for owner / operator	5
2.5 Safety instructions for maintenance, servicing and installation work	6
2.6 Arbitrary modification and production of spare parts	6
2.7 Improper operations	6
2.8 Intended use	6
2.9 Personal protection for maintenance and service	6
3. Transport and storage	7
3.1 General	7
3.2 Storage.....	7
4. Product description	8
4.1 Functional description	8
4.2 Temperature range	8
4.3 Materials.....	8
5. Technical data	8
6. Electrical connection	9
7. Accessoires	9
8. Installation	10
9. Reverse function of the float switch	10
10. Decommissioning	10
11. Disposal	11
11.1 Dismantling and transport.....	11
11.2 Complete disposal	11
12. Clearance certificate	12

Operating instructions

1. General

1.1 General user information

The regulations applicable to the place of installation are to be observed before the commissioning and during the operation of the product from **sera**.

Always read these instructions and particularly the safety instructions before installation and commissioning of the **sera** product.







ATTENTION!

Always ensure that the tank is sufficiently aerated and ventilated!

Check and ensure chemical resistance of the parts that come in contact with the medium!

1.2 Symbols and notes used in these operating instructions

Special notes in these operating instructions are marked with text and danger symbols.

Notes (Text and symbol)	Danger type			Meaning (in the operating instructions)
	Danger to life	Risk of injury	Dam. to property	
DANGER! 	X	X	X	Identifies imminent danger that could lead to death or serious injury if not avoided.
WARNING! 	X	X	X	Indicates a potentially dangerous situation that could lead to death or serious injury and damage to property if not avoided.
CAUTION! 		X	X	Indicates a potentially dangerous situation that could lead to slight or minor injury or damage to property if not avoided.
ATTENTION! 			X	Indicates a potentially dangerous situation that could lead to damage to property if not avoided.
NOTE! 				Indicates information which help to facilitate the work and is useful for a trouble-free operation.

Operating instructions

1.3 Quality instructions

Observance of these operating instructions and, in particular, the safety instructions, helps to

- avoid dangers to persons, machines and environment,
- increase reliability and service life of the product and the complete system,
- reduce repair cost and downtime.

The **sera** quality management and quality assurance system for pumps, systems, valves and fittings and compressors is certified according to ISO 9001:2008.

The **sera** products meet the valid safety and accident prevention regulations.



ATTENTION!

Always keep these operating instructions within reach at the place of installation.



WARNING!

Pay attention to the safety data sheet of the medium! The owner must take corresponding accident prevention measures to protect operating personnel from danger through the delivery media used!

2. Safety instructions

2.1 Personnel qualification and training

The personnel for operation, maintenance, inspection and installation must be suitably qualified for their tasks. The owner must clearly define responsibility and supervision of the personnel.

If the personnel do not have the knowledge required, then personnel is to be trained and instructed correspondingly. Such training can be provided by the manufacturer / supplier upon order of the owner. In addition, the owner has to ensure that personnel have understood the operating instructions completely.

2.2 Dangers in case of inobservance of the safety instructions

Inobservance of these safety instructions can result in danger to persons, hazards to the environment and damage to the product.

Inobservance of the safety instructions may lead to:

- Failure of important functions of the product/system.
- Inobservance of prescribed methods for maintenance and servicing.
- Danger to persons through chemical influences.
- Hazards to the environment through leaking dangerous media.

2.3 Safety conscious working

The safety instructions specified in this operating manual, the national regulations for accident prevention, the safety regulations for the pumped medium valid at the place of installation as well as internal working-, operating-, and safety instructions of the owner are to be observed.

2.4 Safety instructions for owner / operator

Leaking hazardous delivery media supplies are to be disposed off in such a way that any danger to persons and the environment is excluded. The legal regulations are to be observed.

Operating instructions

2.5 Safety instructions for maintenance, servicing and installation work

The owner must ensure that any maintenance-, servicing- and installation work is only entrusted to authorized and suitably qualified personnel who have carefully read and understood the operating instructions.

Only those spare parts are to be used which meet the requirements of the specified operating conditions.

Threaded joints and connections may only be disconnected when the system is not under pressure.

2.6 Arbitrary modification and production of spare parts

Modifications of or changes to the product are only permitted after previous agreement of the manufacturer. Original spare parts and accessories which were approved by the manufacturer are essential for safety reasons.



CAUTION!

If the product is modified without authorization of the manufacturer or spare parts are used which are not approved, any warranty claim becomes null and void.

2.7 Improper operations

Operating safety of the supplied product is only guaranteed if the product is used as intended, according to the descriptions in Chapter „Intended use“ of these operating instructions.

2.8 Intended use

The **sera** product is only to be deployed according to the intended purpose stated in the product description. If the product is to be used for other applications, then the suitability of the suction lance for the new operating conditions must be discussed with **sera** beforehand!

Criteria for operation of the product in accordance with the intended use:

- Observe characteristics of the medium (please see safety- and product data sheet of the delivery medium – the safety data sheet is to be provided by the supplier / owner of the pumped medium).
- Resistance of the materials which come into contact with the pumped medium.
- Operating conditions at the place of installation.
- Temperature of the pumped medium.
- Max. pressure of the product.

2.9 Personal protection for maintenance and service

National safety regulations for the pumped medium must strictly be adhered to.

In case of accidents check whether the following substances are emitted:

- Leaking fluids.
- Leaking vapours.

Emissions are to be monitored by corresponding control systems of the total installation.

Operating instructions



Wear protective clothing, gloves, breathing mask and a face protecting mask.

ATTENTION!



Personal protective equipment must be provided by the owner!

NOTE!



NOTE!



3. Transport and storage

3.1 General

sera - products are checked for perfect condition and function previous to shipment. Check for transport damage immediately after arrival of goods. If damage is found, this is to be reported immediately to the responsible carrier and the manufacturer.



The packaging material must be disposed of appropriately!

NOTE!

3.2 Storage

An undamaged packaging protects the unit during storage and should only be opened when the product is installed.

Proper storage increases the service life of the product and includes prevention of negative influences such as heat, moisture, dust, chemicals etc.

The following storage specifications are to be observed:

- Storage place: cool, dry, dustfree and slightly ventilated
- Storage temperature between +2°C and +40°C
- Relative air humidity not more than 50 %.
- The maximum storage time is 12 months.

Do not store solvents, fuels, lubricants, chemicals, acids, disinfectants and similar in the storage room.

Operating instructions

4. Product description

4.1 Functional description

sera – suction lances are used for the withdrawal of chemicals from tanks. The integrated foot valve prevents the back flow of the inducted medium. The types S-03 have an additional level switch (for signal „empty“).

4.2 Temperature range

The temperature range of the suction lances is between +10 °C and +40 °C (in relation to water).

The temperature range changes depending on the medium ► this must be checked by the owner.

4.3 Materials

Suction lance	PVC-U
Level switch	■ PP
Valve ball	■ glass ■ 1.4401 ■ PTFE
Seals	■ FPM ■ EPDM

5. Technical data

Max. flow rate	200 l/h
Max. viscosity of the medium	100 mPas
Min. density of the medium	1 kg/dm ³
Max. turn-on voltage	48 V / AC/DC
Max. switching current	0,5 A
Max. rupturing capacity	10 W / 12 VA
Enclosure	IP 65 (IEC 529)
Mounting hole	min. 42 mm
Max. pump stroke volume	20 cm ³

Operating instructions

Dimensions

Available lengths (L)

600 mm	1000 mm	1200 mm
--------	---------	---------

1	Ball check valve
2	Induction pipe
3	Level switch
4	Switching point
5	Mounting hole
6	Remaining level

The level indicated for switching point are referring to water. The level will be lower for media with higher density.

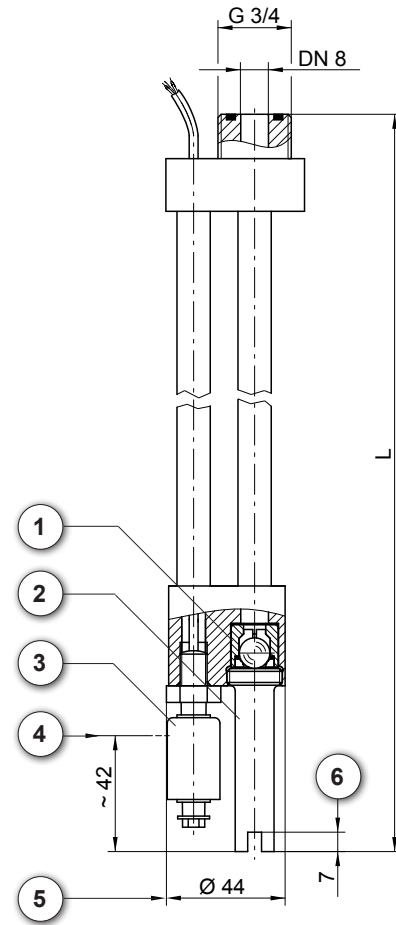

6. Electrical connection

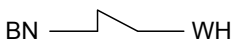
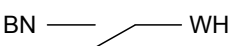
Contact function	Wiring diagram	
<ul style="list-style-type: none"> Level switch one-stage, closing when floating down Type of contact: Reed-contact 	Closing when floating down 	Reverse operating by turning the float switch axially for 180° * 

* see the description in Chap. „Reverse function of the float switch”.

7. Accessories

Image	Designation	Description
	Connection cable	app. 3 m with connection plug M12

Operating instructions

8. Installation



The installation must only be performed by authorised specialist personnel.

ATTENTION!

The suction lance is installed from above into the opening / hole of the tank / tank cover.

9. Reverse function of the float switch

- Remove circlip (2).
- Remove float switch (1), rotate by 180° and push on to the level switch (3).
- Secure with the circlip.

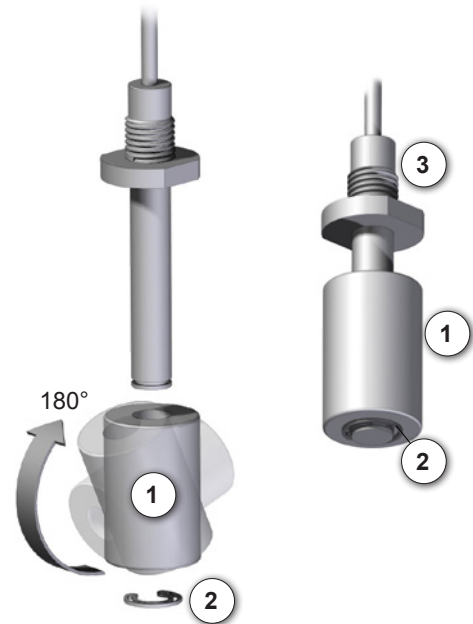

10. Decommissioning

The following points must be observed when you decommission:

- Switch off the unit.
- Disconnect the unit from the power supply.
- Empty the product.



DANGER!

After the chemical was drained, rinse the unit / product with water or a suitable medium until there are no more chemical residues!
Note the compatibility of the rinsing medium with the chemical according to the safety data sheet.

Exothermic reactions must be avoided by all means!

Operating instructions

11. Disposal

- Shut-down the product. Please see "Decommissioning".

11.1 Dismantling and transport

- Package the suction lance and ship.



NOTE!

A clearance certificate must be filled in when systems are returned to the manufacturer (see Chapter „Clearance certificate“).

Acceptance will be rejected if this clearance certificate is not attached.



WARNING!

The consignor is responsible for leaking fluids!

11.2 Complete disposal

- Remove all fluid residues.
- Dismount materials and send them to a suitable waste disposal company!



WARNING!

The consignor is responsible for leaking fluids!

Operating instructions

12. Clearance certificate



NOTE!

Inspection / repair of machines and machine parts is only carried out after the opposite clearance certificate was filled in correctly and completely by authorized and qualified personnel.



NOTE!

Acceptance will be refused if parts are returned to the manufacturer without a proper clearance certificate.

All industrial companies are obligated by the legal provisions for occupational health, e.g. the workplaces ordinances, the Ordinance on Hazardous Substances, the regulations for prevention of accidents and the environmental protection regulations such as the Waste Management Act and the German Household Water Act to protect their employees or man and the environment from detrimental effects when handling hazardous substances.

Should special safety precautions be necessary despite careful draining and cleaning of the product the necessary information are to be provided.

Machines which are operated with radioactive media shall only be inspected and/or repaired in the safety area of the owner by a sera specialized fitter.

The clearance certificate is part of the inspection-/repair order.
sera reserves the right to refuse acceptance of the order for other reasons.



NOTE!

Please make a copy and leave the original with the operating instructions!
(can also be downloaded from: www.sera-web.com)

Operating instructions

Clearance Certificate

Product

Type

Serial-No.

the product was carefully emptied before shipping / delivery, and cleaned inside and outside. YES

Conveying medium

Designation

Concentration

 %

Properties

Please tick!

If either of the listed properties, then enclose the appropriate safety and handling instructions.



Harmless



Toxic



Corrosive



Flammable



Oxidising



Unhealthy



Explosive



Dangerous for the environment



Irritant



Bio-hazardous



Radioactive

The product was used with health or water-polluting substances and came up with labeling requirements and pollution prone media in contact. YES NO

Special security arrangements with respect to health or water-hazardous media are in the further handling not required required

The following safety precautions regarding rinsing, residual liquids and waste disposal are required:

Process data

The product was used with the following operating conditions described conveying medium:

Temperature

 °C

Pressure

 bar

Sender

Company: _____

Telephone: _____

Contact person: _____

FAX: _____

Address: _____

E-mail: _____

Zip code, City: _____

Your order No: _____

We confirm that we have the information in this safety certificate (Clearance Certificate) have been correctly and completely and that the returned parts were carefully cleaned.

The parts are sent free of residues of dangerous amount.

Place, Date

Department

Signature
(and company stamp)

NOTES

NOTES

