

CONTROL C410.2 / C204.1



NOTE

Keep the operating manual for future use!

ATTENTION

Subject to technical modifications!

Quality notes

The **sera** quality management and quality assurance system is certified in accordance with DIN EN ISO 9001:2015. The **sera** product complies with the applicable safety requirements and accident prevention regulations.

About this instructions

Special notes in these instructions are marked with text and danger symbols.

NOTE

Notes or instructions that facilitate work and ensure a safe operation.

ATTENTION

The non-observance of these safety instructions can result in malfunctions or material damages.

WARNING

The non-observance of these safety instructions can lead to material damages and personal injuries.



Note on the additional instructions „SAFETY INSTRUCTIONS SI01“.

These technical manual is divided into the following main parts:

TRANSPORT & STORAGE / AMBIENT CONDITIONS	page 6
ELECTRICAL CONNECTIONS	page 7
OPERATION	page 14
FAULT CORRECTION / FAULT ANALYSIS	page 47
MAINTENANCE / DECOMMISSIONING / DISPOSAL	page 49

TRANSPORT & STORAGE / AMBIENT CONDITIONS	6
General	6
Storage.....	6
AMBIENT CONDITIONS	6
TEMPERATURE DATA	6
ELECTRICAL CONNECTIONS	7
Electric supply C204.1	7
Electric supply C410.2	8
Electrical interfaces	9
OPERATION	14
Operating elements.....	14
LED operation indicators	14
Key operation	15
Parameter table	16
Menu	18
Screen „Operating messages“	18
Display of the current operation mode	18
Fault and warning messages	19
Screen “Main menu”	20
Value entry	20
Menu guide.....	22
Selecting the operation mode	27
Additional settings for the operation mode	27
Additional settings for the ANALOG mode.....	28
Additional settings for the PULSE mode	32
Additional settings for the BATCH mode.....	33
Settings for the EXTERNAL operation mode.....	35
Configuring the inputs and outputs	35
Digital input 01	36
Digital/analog inputs 02 and 03	37
Outputs 01 and 02	37
Calibration	40
System	42
Totalizer	42
Password	42
Info	44
Extras	44
Slow-Mode (C410.2...)	44
Dosing monitoring	44
Diaphragm rupture detection	45
Level monitoring	46
FAULT CORRECTION / FAULT ANALYSIS	47
MAINTENANCE / DECOMMISSIONING / DISPOSAL	49
Maintenance and cleaning.....	49
Decommissioning	49
Disposal.....	49

WARNING

Observe and follow the safety instructions by all means.
See the additional instructions „SAFETY INSTRUCTIONS“.
Man, machine and environment are endangered if the safety instructions are not observed.



General

sera products are checked for perfect condition and function previous to shipment.
Check for transport damage immediately after arrival of goods. If damage is found, this is to be reported immediately to the responsible carrier and the manufacturer.

Storage

An undamaged packaging protects the unit during storage and should only be opened when the product is installed.
Proper storage increases the service life of the product and includes prevention of negative influences such as heat, moisture, dust, chemicals etc.

The following storage specifications are to be observed:

- Storage place: cool, dry, dustfree and slightly ventilated
- Storage temperature and relative air humidity see Chapter „TECHNICAL DATA“.
- The maximum storage time for the standard packaging is 12 months.

If these values are exceeded, metal products should be sealed in foil and protected from condensation water with a suitable desiccant.

Do not store solvents, fuels, lubricants, chemicals, acids, disinfectants and similar in the storage room.

AMBIENT CONDITIONS

Max. relative humidity	< 90%
------------------------	-------

TEMPERATURE DATA

Max. operating temperature	40 °C
Min. operating temperature	0 °C
Max. storage temperature	40 °C
Min. storage temperature	0 °C

WARNING

Observe and follow the safety instructions by all means.
See the additional instructions „SAFETY INSTRUCTIONS“.
Man, machine and environment are endangered if the safety instructions are not observed.

**ATTENTION**

The pump restarts in the selected operating mode after the power supply was switched on or a power supply recovery following a mains failure!

ATTENTION

Switching the voltage supply on and off temporarily is to be avoided!
A waiting time of at least two minutes must be observed between switching the pump off and on again!

ATTENTION

Only operate the pump when it is connected to an earthed power supply!

Electric supply C204.1

The **sera** diaphragm pump C204.1 is delivered ready for installation. Standard delivery includes a 2m power cable with Euro plug. The standard version C 204.1 of the dosing pump is designed for an operating voltage range of 100 – 240V, 50/60Hz.

Symbol:

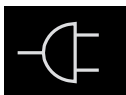

Electric supply C410.2

The sera diaphragm pump is delivered ready for connection with a 2m mains cable and a CEE-socket/ 16A 5-poles 6h. The diaphragm pump is designed for an operating voltage range of 380 – 420 V, 50/60 Hz.

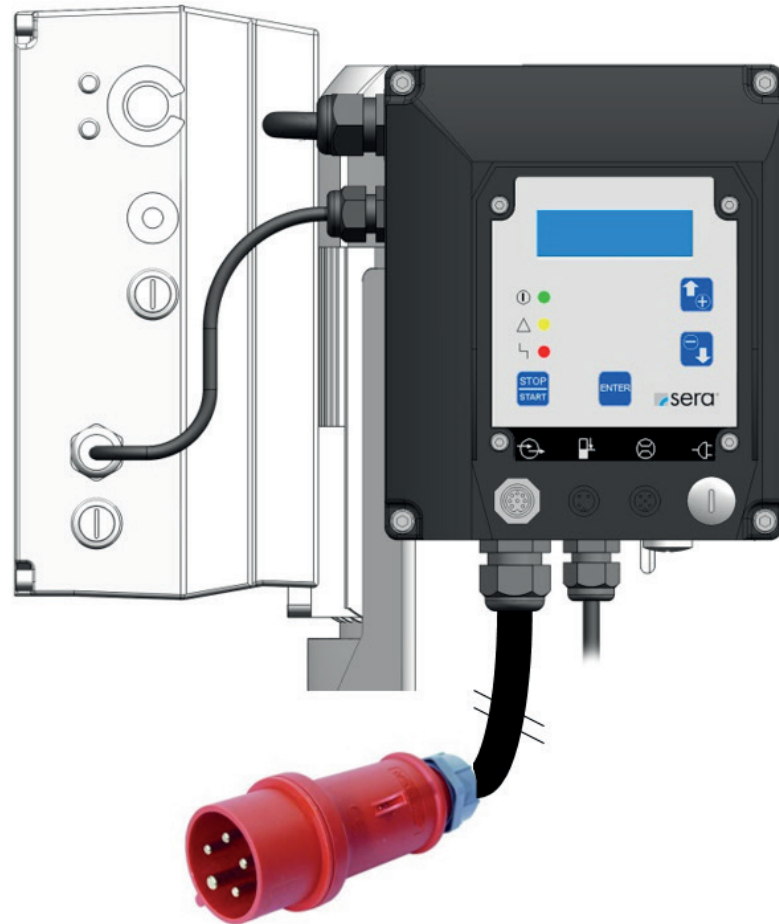

The mains connection requires 3~ 400V + neutral conductor + protective conductor.
The leakage current against earth amounts to approx. 7 mA.
Recommended protection: 3-poles automatic fuse C10A.

Electrical interfaces

The connectors for the electrical interfaces are located on the back of the pump below the control panel.

Control inputs and outputs

The pump is equipped with three control inputs and two control outputs. They can be programmed with different functions. All three inputs can be used as digital inputs, whereas two of them can optionally be configured as analog inputs (inputs O2 and O3, see Chapter „Digital/analog inputs O2 and O3“). When leaving the factory, the inputs and outputs are preset as described in table.

Symbol:

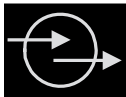

Connector socket for control inputs and outputs

Standard delivery of the dosing pump includes a 5m control cable, which is to be connected to the 8-pin socket of the control inputs and outputs. The following table shows the identification of the individual leads of the control cable.

Lead colour	Pin	Function (ex works setting)
WH (white)	1	Input O1 (pulse)
BN (brown)	2	Input O2 (analogue O1)
GN (green)	3	Input O3 (external ON)
YE (yellow)	4	Output + / signal + / 15 V DC
GY (grey)	5	Output O1 (collective fault)
PK (pink)	6	Output O2 (stroke signal)
RD (red)	7	Ground
BU (blue)	8	Ground

The digital inputs can not only be switched by a potential-free contact signal but also directly via a control voltage signal (e.g. 24V DC).

This enables, for example, the direct connection of a programmable logic controller to the dosing pump.

ATTENTION

When an external supply (for example, 24 V DC) is connected to the pin output + (colour of cable lead: yellow) the following has to be considered:

A protective diode is necessary in the feeding pipe of the external supply in order to exclude a feeding back of the pump. (see fig. „Control of digital inputs via a potential-free contact signal“).

Connect the anode with 24V DC.

Connect the cathode with the yellow lead of a cable.

Use the diode type 1N4007 or the like.

The following figure shows exemplarily the control of the digital inputs O1 and O3 via a potential-free contact signal.

ATTENTION

The outputs O1 and O2 are not potential-free! In order to enable a potential-free switching via the outputs, the use of a relay is necessary.

ELECTRICAL CONNECTIONS

Control of digital inputs via a potential-free contact signal:

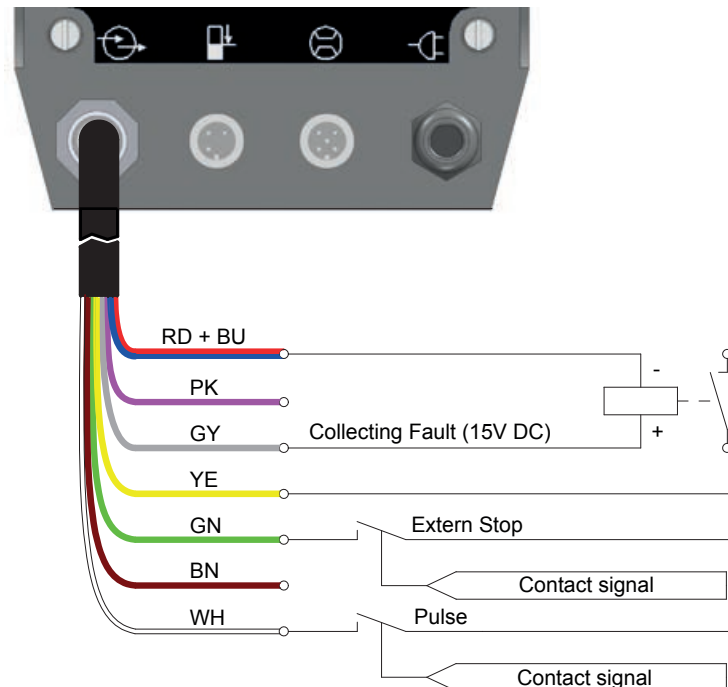

⚠ ATTENTION

The maximum voltage/maximum current withstand capability of the control inputs and outputs is as follows:

Inputs: 30V DC / 50mA

Outputs: 15V DC / 50mA (internal supply)
30V DC / 350mA (external supply)

⚠ ATTENTION

The output + / signal + connection pin (lead colour: yellow) is not short-circuit proof! In case of a short-circuit, the control electronics may get damaged!

Therefore, please make absolutely sure that the signal + connection pin is not directly connected with the earth connections (lead colour: red and blue)!!

Fig. shows exemplarily the direct activation of the digital inputs 01 and 03 via a control voltage signal (in this example: 24V DC) of a programmable logic controller.

Direct activation of digital inputs via a control voltage signal of a programmable logic controller:

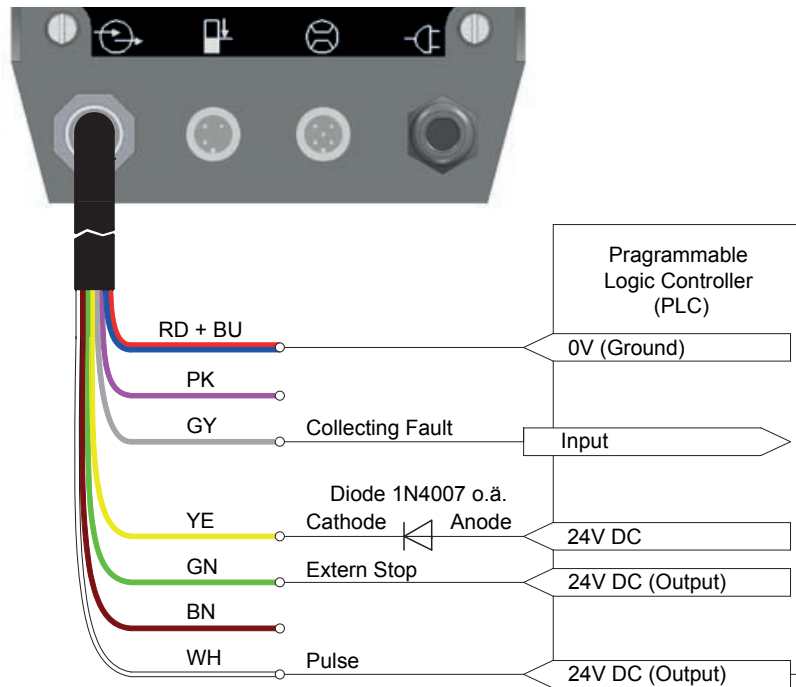

Level input with pre-alarm and dry run

i NOTE

Pre-alarm and dry run are connected to the same jack.
 When leaving the factory, both inputs are preset to "closing when floating down".
 However, if necessary, they can be freely configured.

Symbol:

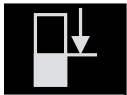

Jack for level input

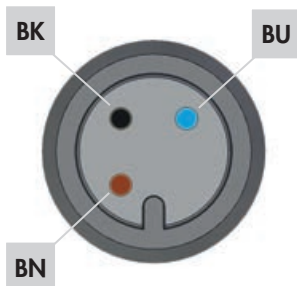

Wire colour	Pin	Function (factory setting)
BN (brown)	Pin 1	Pre-alarm level
BU (blue)	Pin 3	Ground
BK (black)	Pin 4	Dry-Running

The inputs can be switched using a floating contact signal.
 Pre-alarm and dry running are set to normally open floating contacts at the factory.
 The sockets of the connections are A-coded and the assignments of the functions are symbolically labelled.

Input for flow control and flow meter

ATTENTION

Only flow controllers and flow meters made by **sera** may be connected to the dosing pump. If you use other than **sera** products, the electronics might get damaged.

Symbol:

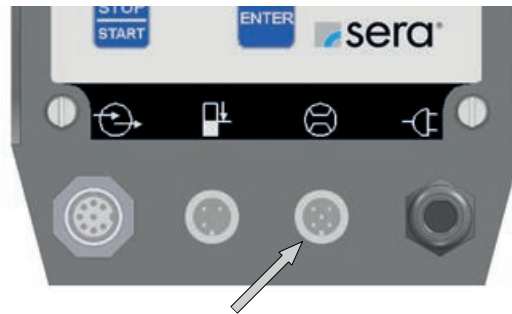

Jack for flow control / flow meter

sera flow controllers and flow meters are delivered completely with cable and plug. Electrical connection is made directly to the 5-pin socket.

WARNING

Observe and follow the safety instructions by all means. See the additional instructions „SAFETY INSTRUCTIONS“. Man, machine and environment are endangered if the safety instructions are not observed.



Operating elements



1	STOP/START button	5	DOWN button
2	LED indication	6	ENTER button
3	LCD display	7	Stroke length adjustment
4	UP button		

LED operation indicators

Three light-emitting diodes (LED) indicate the status of the pump:

Green: Operation and stroke indicator	
	When switching on the pump, the green LED lights steadily. The operation indicator works in combination with a stroke indicator; during pump operation, the LED flashes in accordance with the current stroke frequency.
Yellow: Warning indicator	
	The yellow LED indicates all occurring warning messages (see the following table). The warning is not only indicated by the LED but also as plain text in the LCD display.
Red: Fault indicator	
	The red LED indicates all occurring faults (see the following table). The fault is not only indicated by the LED but also as plain text in the LCD display.



Overview of LED indicators	Green LED	Yellow LED	Red LED
	 	 	 
Ready	On		
Stroke confirmation	Flashes		
Internal error			On
Supply voltage too low / too high		On	
No mains			
Level monitoring			
Level pre-alarm		Flashes	
Dry run			Flashes
Dosing control (flow controller or flow meter)			
No flow - with warning message		On	
No flow - with shut-off			On
Flow too low - with warning message		On	
Flow too low - with shut-off			On
Diaphragm rupture monitoring			
Diaphragm rupture			On
Analog mode			
mA signal < 3,5 mA			On
mA signal > 20,5 mA			On

i NOTE

The “dry run” fault message suppresses the “pre-alarm” warning. This means that if the pump runs dry while the 2-stage level monitoring is activated, then only the red LED will flash.

Key operation

Operation of the pump is performed with 4 keys:

STOP/START key	
	After connection to the power supply, the pump is switched ON/OFF using the STOP/START key.
ENTER key	
	You can use the ENTER key to open and confirm value input fields and to select menu items.
UP- / DOWN key	
	Using the UP/DOWN key, you can scroll the different menu items / menu levels and select the display of various operating messages. During parameter adjustment, the UP key is used to increase the parameter value and the DOWN key is used to decrease the parameter value.

Parameter table

The table shows the factory settings of the controllable diaphragm pump. With these defaults, the user can start standard applications such as manual operation, analog operation with 4-20mA, 1/1 pulse operation and external operation with External ON, without having to make further adjustments. It is only necessary to select the operation mode from the respective menu (see Chapter „Selecting the operation mode“) and, in case of external control, to connect the respective input (see Chapter „Control inputs and outputs“).

The references to the respective chapters facilitate the adjustment of the settings to special applications and dosing tasks. In addition, the parameter table offers the possibility to document the changes that have been made in the settings. Thus, the current settings of the pump can be viewed quickly at any time.

Overview of preset parameters

	Factory settings	page	Adjustment	Modification 1	Modification 2
Pulse operation		page 32			
Pulse mode	1/1				
Pulse factor	1				
Pulse memory	ON				
Analog mode		page 28			
Analog mode ⁽¹⁾	Auto				
Analog signal	4-20mA				
Adjustment:: Analog I1	4mA				
Adjustment:: Frequency f1	0%				
Adjustment:: Analog I2	20mA				
Adjustment:: Frequency f2	100%				
Batch mode		page 33			
Batch control	manual				
Batch quantity	0 strokes				
Batch start	00:00 h				
External mode		page 35			
Stroke freq.	100 %				
Input 01		page 36			
Function E1	Pulse				
Contact E1	Normally open				
Input 02		page 36			
Function E2	Analog 01				
Contact E2	Normally open				
Input 03		page 36			
Function E3	External ON				
Contact E3	Normally open				
Output 01		page 37			
Function A1	Collective fault				
Contact A1	Normally closed				

	Factory settings	page	Adjustment	Modification 1	Modification 2
Output 02		page 37			
Function A2	Stroke signal				
Contact A2	Normally open				
Dosing monitoring		page 44			
Sensor	OFF				
Function	Message				
Fault stroke	10				
Alarm limit	80 %				
Level		page 46			
Pre-alarm	Normally open				
Dry run	Normally open				
System		page 42			
Language	German				
Calibration	OFF				
SLOW-Mode (C410.2...)		page 44			
SLOW-Mode	OFF				
Drehzahl	80%				
Password		page 42			
PW01-mode	OFF				
Password 01	9990				
Password 02	9021				
Diaphragm rupture indication		page 45			
Input signal	Normally open				
Sensitivity	50%				

⁽¹⁾ only with C410.2...

Menu

You can switch between the following three screens:

- Operating messages
- Main menu
- Fault and warning messages

A change to the screen "Fault and warning messages" is only possible when a fault or warning is present.

A change between the screens "Operating messages" and "Main menu" is done by simultaneously pressing the UP and DOWN keys.

A change between the screens "Operating messages" and "Fault and warning messages" is done by simultaneously pressing the ENTER and DOWN keys.

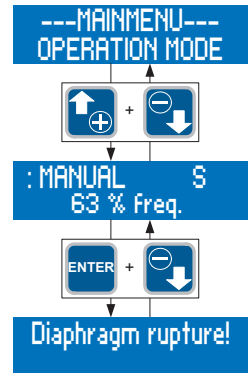

i NOTE

After, in the main menu, no key has been pressed for 3 min. the screen "Operating messages" is automatically displayed.

Screen „Operating messages“

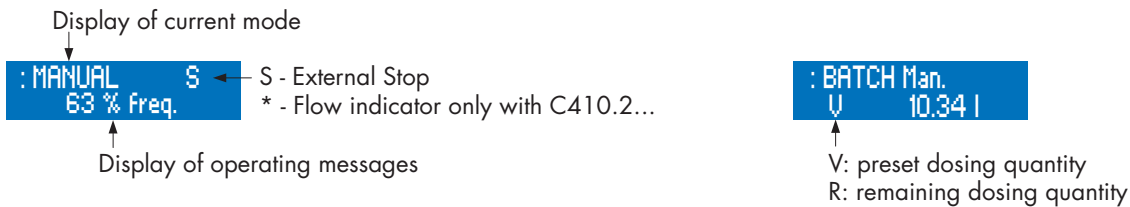

Display of the current operation mode

The first line in the screen "Operating messages" shows the currently set operation mode.

Flow indicator

A star-symbol (*) in the first line on the right-hand side is used as flow indicator. The star symbol indicates the response of a connected dose monitoring instrument (flow control or flow meter).

i NOTE

The flow indicator (*) is only active when a flow control / flow meter is connected and the dosing monitoring is activated (see Chapter „Slow-Mode“ only with C410.2...).

Display of operating messages

The second line of the display shows, dependent on the set operation mode, a variety of operating messages (e.g. the current stroke frequency, total strokes – see Tab). The operating messages can be scrolled using the UP and DOWN keys. You can use the ENTER key to open the value input fields of the editable operating messages (see Tab.). The value input is described in Chapter „Value entry“.

Operating messages in dependence on the selected operation mode

Operating messages	Operation mode				
	Manual	Analog	Pulse	Batch	External
Current stroke frequency	<input type="radio"/> ⁽¹⁾	<input checked="" type="radio"/>	<input checked="" type="radio"/>	<input checked="" type="radio"/>	<input checked="" type="radio"/>
Current dosing performance ⁽²⁾	<input type="radio"/>	<input checked="" type="radio"/>			
Total strokes	<input type="radio"/>	<input type="radio"/>	<input type="radio"/>	<input type="radio"/>	<input type="radio"/>
Total dosing quantity ⁽²⁾	<input type="radio"/>	<input type="radio"/>	<input type="radio"/>	<input type="radio"/>	<input type="radio"/>
Current control current		<input checked="" type="radio"/>			
Pulse factor			<input checked="" type="radio"/>		
Memory			<input checked="" type="radio"/>	<input checked="" type="radio"/>	
Dosing quantity / strokes				<input checked="" type="radio"/>	
Remaining dosing quantity / remaining strokes				<input checked="" type="radio"/>	
Manual start				<input checked="" type="radio"/>	

= Indication

= Indication and setting option

⁽¹⁾ = not with a calibrated pump

⁽²⁾ = only with a calibrated pump

Fault and warning messages

When a fault or warning has occurred, the dosing pump shows a message in plain text format on the LCD display.

i NOTE

The message disappears automatically when the cause of the fault or warning has been eliminated.

Screen “Main menu”

The upper line shows the superordinate menu items or editable parameters. The lower line shows the subordinate menu items or selectable values and settings.

Superordinate menu items are marked with “-”. Superordinate means that no values or settings can be assigned to this item. It is, for example, possible to select a variety of subordinate menu items (e. g. ANALOG MODE) in the -PARAMETER- menu but these items cannot be assigned to the superordinate menu as a fixed value.

Parameters which can be assigned different values or settings are marked with “>” and “<”. Such parameters are, for example, the operation mode, the analog signal or the pulse mode. Each parameter should be assigned a definitive value or setting. The >OPERATION MODE< can, for example, be assigned the ANALOG setting.

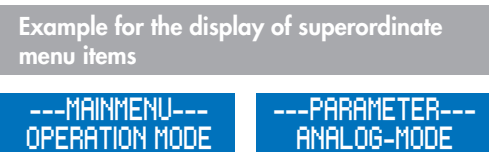

Value entry

The assignment of values and settings to a parameter is described in the following, using two exemplary illustrations.

Assignment of settings

Display of the current setting (in this example: MANUAL operation mode).

Value entry is enabled after pressing the ENTER key.

Then, the operation mode indicator flashes and a setting can be selected (in this example: operation modes) using the UP and DOWN keys.

After a setting has been selected (in this example: ANALOG mode), pressing the ENTER key will confirm and save the choice.

Display of the current setting (in this example: ANALOG mode).

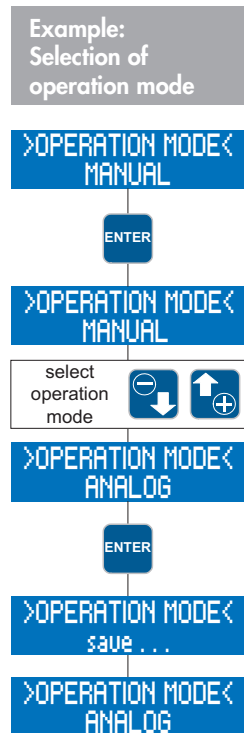

Assignment of values

Display of the current value (in this example: pulse factor 1/1).

Value entry is enabled after pressing the ENTER key.

Then, the first digit of the pulse factor flashes.

The desired figure can be set using the UP and DOWN keys (in this example: 1).

After having selected the desired figure, pressing the ENTER key will confirm the choice.

Then, the second digit of the pulse factor starts to flash.

The desired figure can be set using the UP and DOWN keys (in this example: 0).

After having selected the desired figure, pressing the ENTER key will confirm the choice.

Then, the third digit of the pulse factor starts to flash.

The desired figure can be set using the UP and DOWN keys (in this example: 0).

After having selected the desired figure, pressing the ENTER key will confirm the choice.

Afterwards, the entered value will be saved.

Display of current value (in this example: pulse factor 100/1).

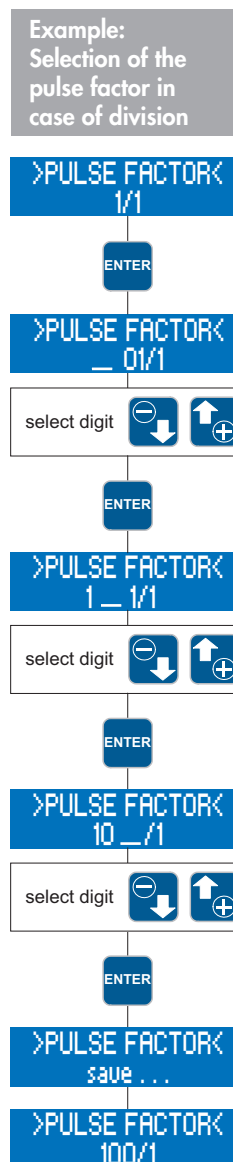

The value entry (flashing indication) can be exited by simultaneously pressing the UP and DOWN keys. In this case, the previous value / previous setting will be maintained.

i NOTE

If, during the value entry (flashing indication), no key has been pressed for 30 sec. the entry mode is exited automatically and the previous value / previous setting is maintained!

Menu guide

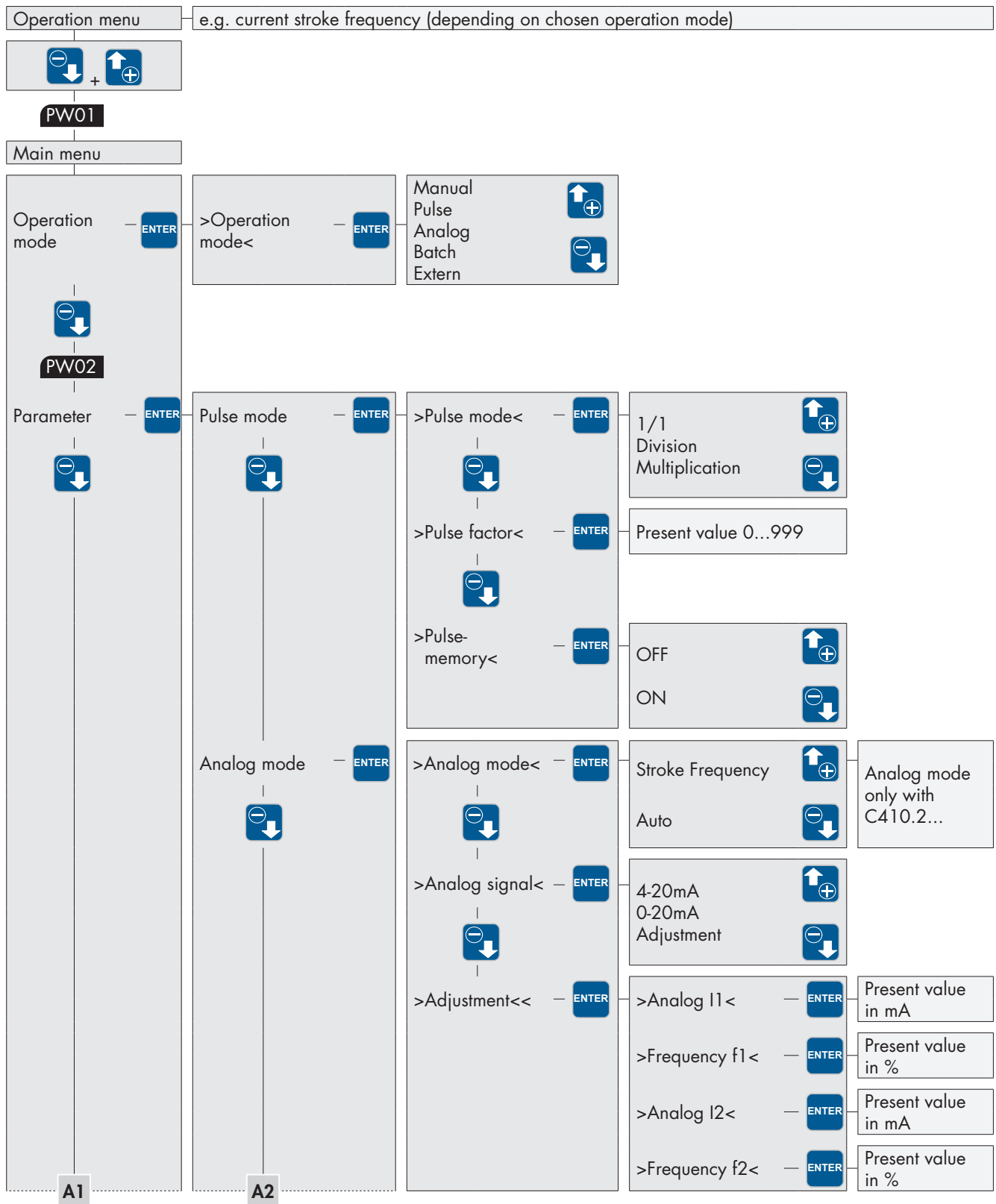

PW01 Locking by Password 01 (pre setting ex work: 9990, not activated)

PW02 Locking by Password 02 (pre setting ex work: 9021)

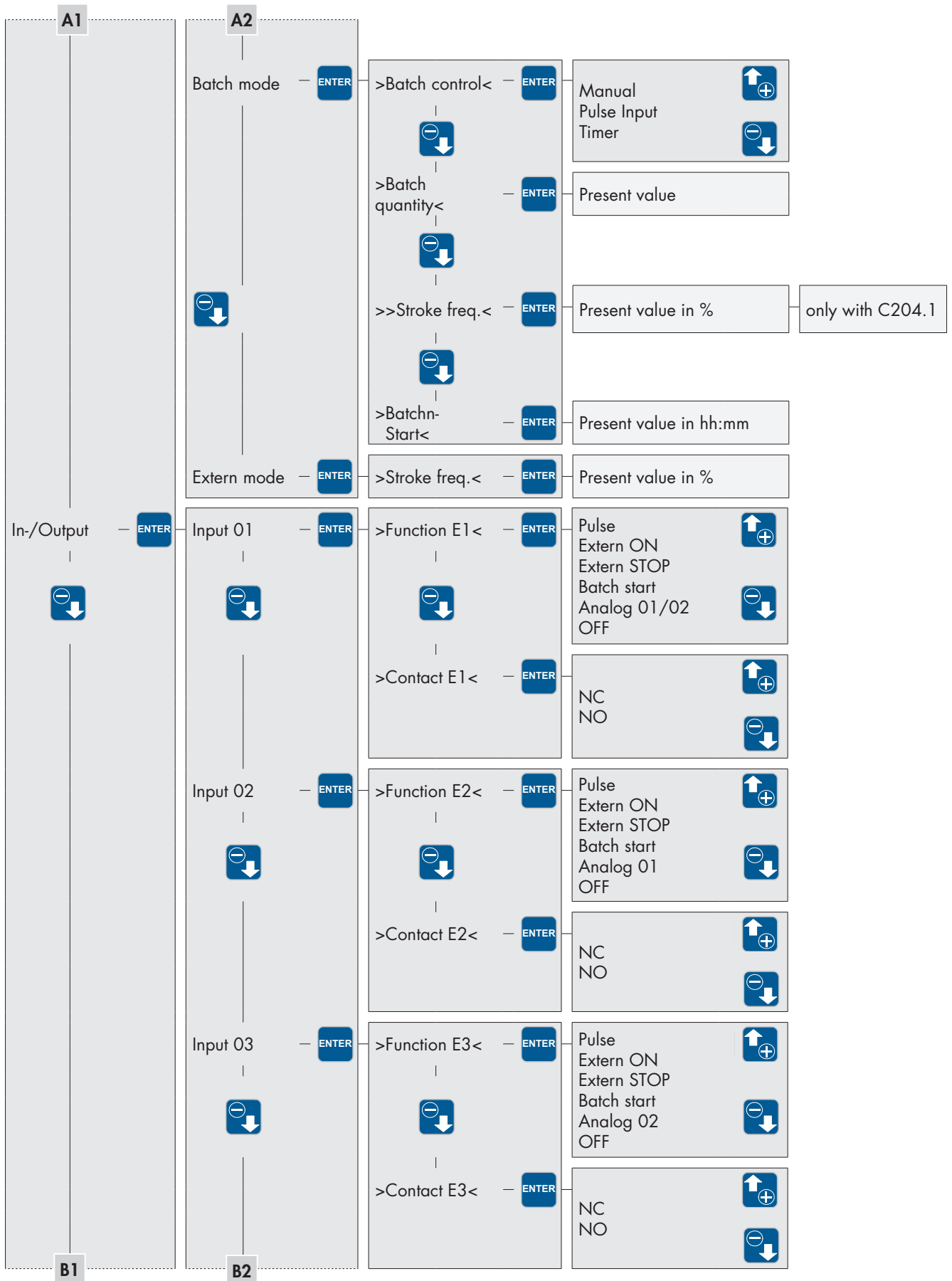

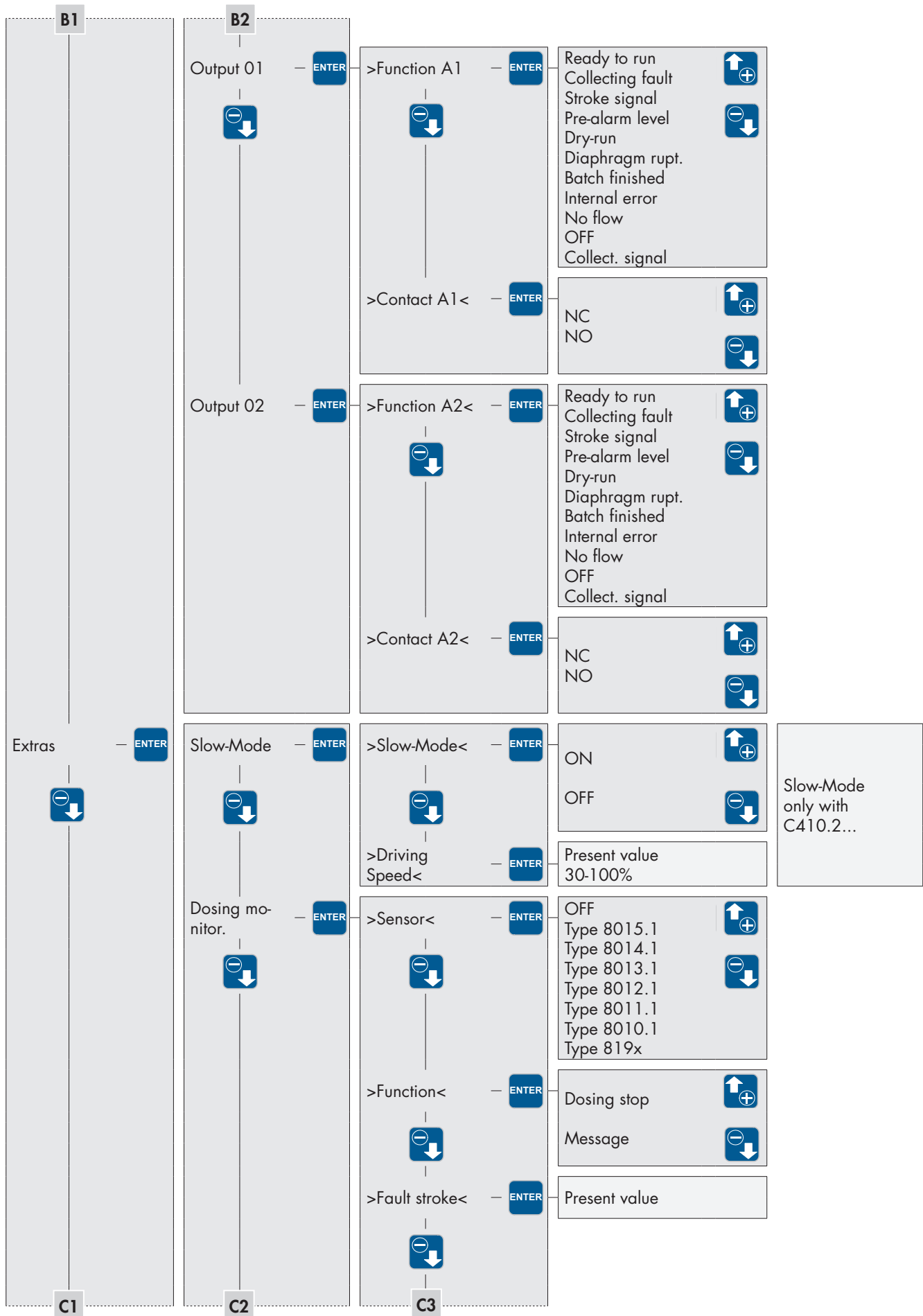

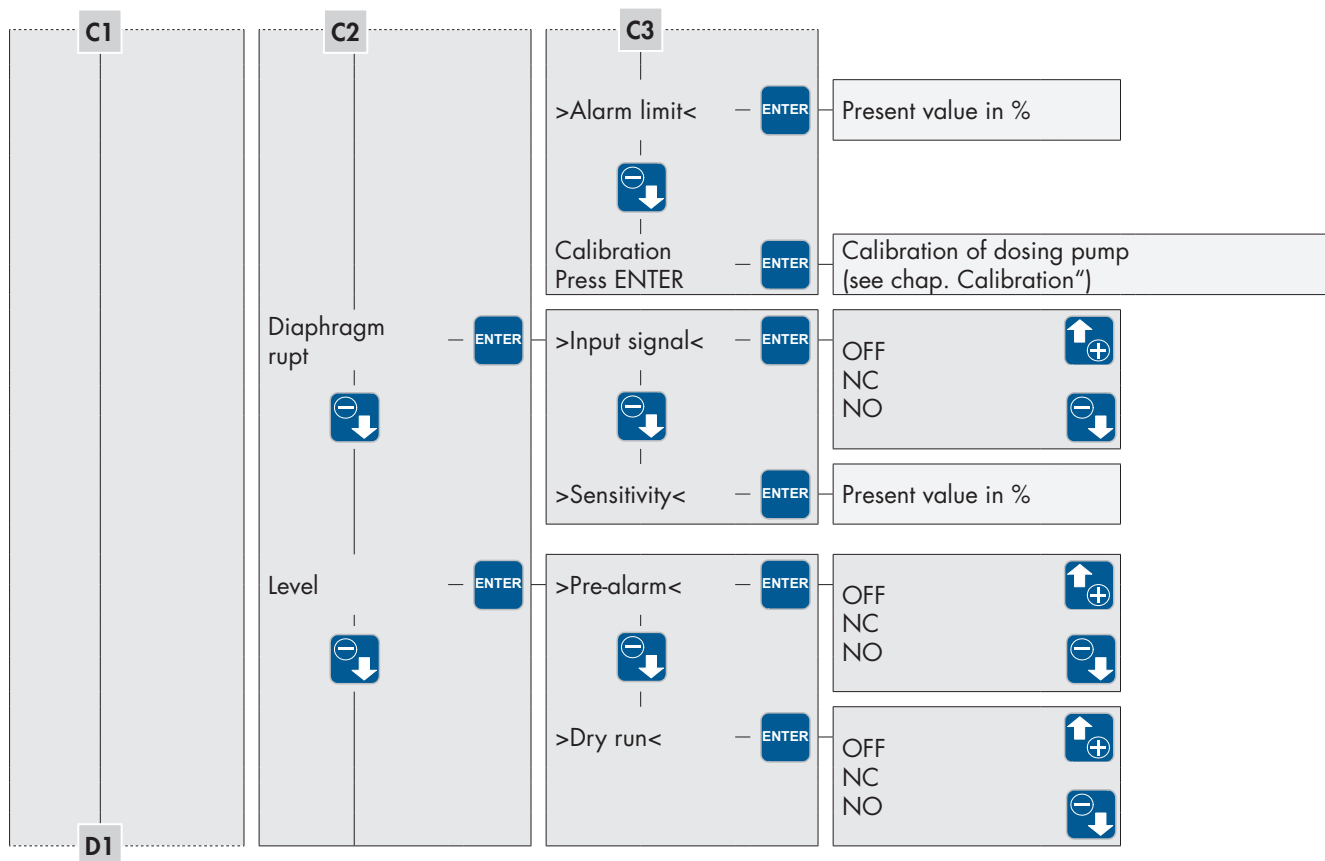

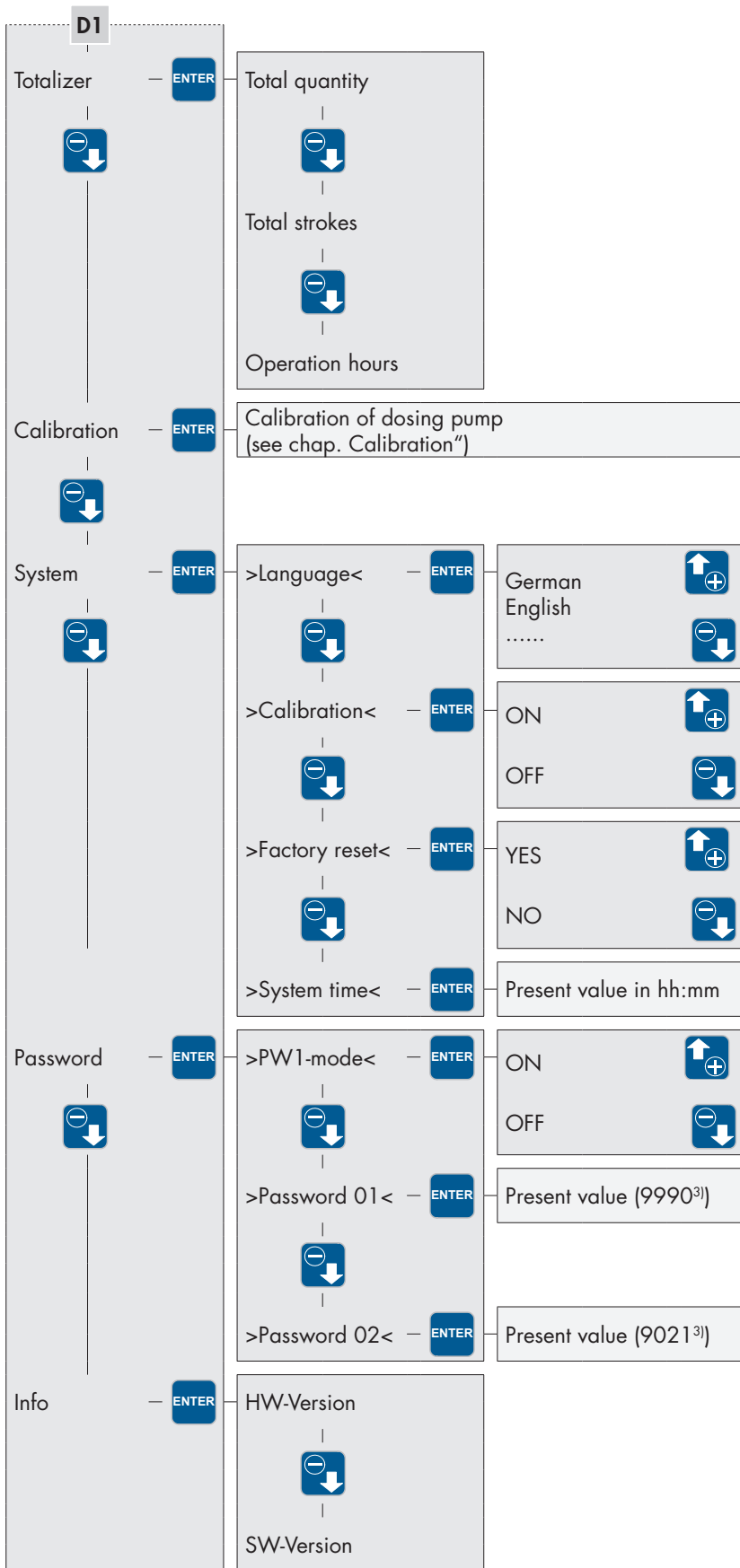

³⁾ pre setting ex work

Selecting the operation mode

You can select among five different operation modes:

- MANUAL
- PULSE
- ANALOG
- BATCH
- EXTERNAL

can be set via the manual stroke length adjustment and/or by presetting a stroke frequency. With a calibrated pump, the delivery rate is set in l/h instead of via the stroke frequency.

The pump is released or blocked via an external switch. If the pump is released, it will run at the preselected stroke frequency (see Chapter „Settings for the EXTERNAL operation mode“).

Batch dosing that can either be started manually, via an external pulse signal or by time control. The batch quantity can be entered in strokes or in liters (only with a calibrated pump) (see Chapter. „Additional settings for the BATCH mode“).

The stroke frequency of the pump is controlled via the received analog signal. The pump can optionally be controlled with a control current of either 0...20mA or 4...20mA. In addition, there is the possibility to adjust the receiving analog signal according to needs (see Chapter. „Additional settings for the ANALOG operation mode“).

Three pulse modes are offered. The pump can either be operated in the 1/1 mode or with multiplication or division of the input pulses (see Chapter. „Additional settings for the ANALOG operation mode“).

Go to the –MAIN MENU– and select the menu item OPERATION MODE (if necessary, use the UP / DOWN keys).

Pressing the ENTER key will open the >OPERATION MODE< submenu.

Here, the currently set operation mode is indicated (in this example: MANUAL).

The adjustment of an operation mode is done in accordance with the description in Chapter „Value entry“.

>OPERATION MODE<
MANUAL

>OPERATION MODE<
EXTERN

>OPERATION MODE<
BATCH

>OPERATION MODE<
ANALOG

>OPERATION MODE<
PULSE

Setting diagram

---MAINMENU---
OPERATION MODE

ENTER

>OPERATION MODE<
MANUAL

Additional settings for the operation mode

Depending on the selected operation mode, specific settings can be made.

Go to the –MAIN MENU– and select the menu item PARAMETER (if necessary, use the UP / DOWN keys).

Pressing the ENTER key will open the – PARAMETER – submenu.

Here, the currently set operation mode is indicated in this example: ANALOG MODE).

The DOWN key is used to move to the respectively next operation mode. The UP key is used to move to the previous operation mode. When in the PULSE MODE, the UP key is used to move back to the –MAIN MENU–.

---MAINMENU---
PARAMETER

ENTER

---PARAMETER---
ANALOG-MODE

select operation mode

ENTER

OPERATION

After having selected the operation mode, the ENTER key can be used to move to the specific settings for the selected operation mode.

i NOTE

In the –PARAMETER– menu, there is no adjustment possibility for the MANUAL operation mode.

Additional settings for the ANALOG mode

i NOTE

In order to be able to use the ANALOG operation mode, at least one input must be assigned the ANALOG 01 or ANALOG 02 function (see Chapter „Digital/analog inputs 02 and 03“). Input 02 (see Chapter „Control inputs and outputs“) is factory preset to analog input (ANALOG 01).

Choose the ANALOG MODE (C410.2...)

Two different analog modes can be chosen:

- Auto
- Stroke frequency

The motor speed is adjusted corresponding to the stroke frequency. If the stroke frequency falls below 30% operation changes to Stop&Go.

Stop&Go operation covering the whole stroke frequency range, that means every stroke is performed with full motor speed.

>ANALOG-MODE<
AUTO

>ANALOG-MODE<
STROKE FREQUENCY

Selecting the ANALOG SIGNAL

You can select among three different analog signals:

- 4-20mA
- 0-20mA
- ADJUSTMENT

A signal with a control current of 4mA corresponds to 0% stroke frequency; a signal with 20mA corresponds to 100% stroke frequency. In this range, the stroke frequency behaves proportionally to the control current (see following Fig.).

If the input signal is < 3.5mA, then the pump emits the error message "Analogsignal < 4mA". Thus, a wire breakage (control current = 0mA) can be detected.

If the input signal is > 20.5mA, then the pump stops and the error message "Analogsignal > 20 mA" is emitted.

>ANALOGSIGNAL<
4-20mA

>ANALOGSIGNAL<
0-20mA

A signal with a control current of 0mA corresponds to 0% stroke frequency; a signal with 20mA corresponds to 100% stroke frequency. In this range, the stroke frequency behaves proportionally to the control current (see following Fig.).

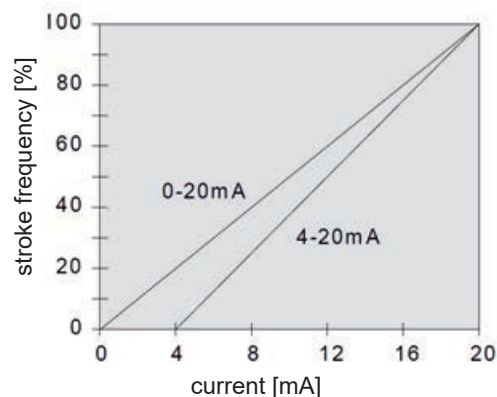

The analog control signal can be adjusted according to needs. This is, for example, necessary if a connected regulator provides a limited output signal.

Two points are given that reflect a proportional relation between control current and stroke frequency of the pump. In addition, these two points restrict the stroke frequency range of the pump as shown in the following Fig.

>ANALOG SIGNAL<
ADJUSTMENT

Example: adjustment of the analog signal

- Point 1: 15 % stroke frequency at 5 mA
- Point 2: 80 % stroke frequency at 15 mA

If the control current is < 5mA, then the stroke frequency of the pump is 0%.

If the control current is > 15mA, then the stroke frequency of the pump is 80%.

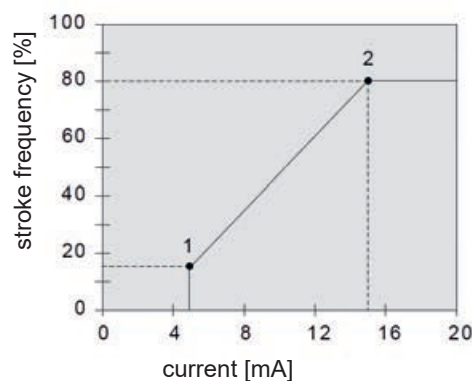

⚠ ATTENTION

If the input signal is greater than 25 mA, the pump stops and a fault indicator „analog signal > 25 mA“ is emitted. Additionally in this case, the appropriate input will be switched off as protective measure. The input is reactivated after the dosing pumps is switched off and started again via the button STOP/START.

Connection of two analog signals with switch-over:

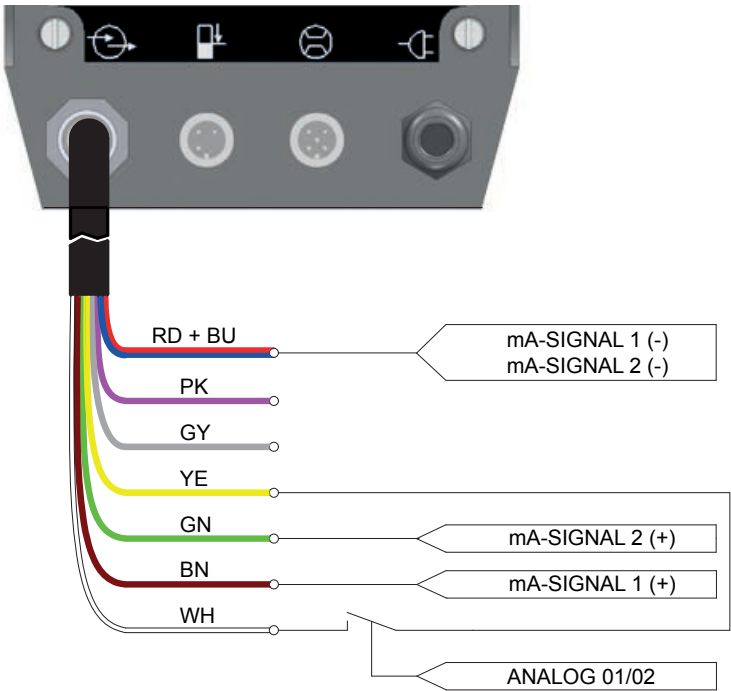

ADJUSTMENT of the analog signal

The adjustment of the analog signal is done under consideration of two default points. These two points are two value pairs which assign control currents to stroke frequencies:

- Point 1 (I1, f1)
- Point 2 (I2, f2)

The following diagram shows the procedure to determine the points:

Go to the –PARAMETER– menu and select the ANALOG MODE menu item using the ENTER key.

Use the DOWN key to skip the selection of the ANALOG SIGNAL.

Select the –ADJUSTMENT–submenu using the ENTER key.

Enter the value for current I1. To do so, proceed as described in Chapter „Value entry“.

Enter the value for stroke frequency f1 which is assigned to current I1. To do so, proceed as described in Chapter. „Value entry“.

Enter the value for current I2. To do so, proceed as described in Chapter „Value entry“.

Enter the value for stroke frequency f2 which is assigned to current I2. To do so, proceed as described in Chapter „Value entry“.

The adjustment is then completed.

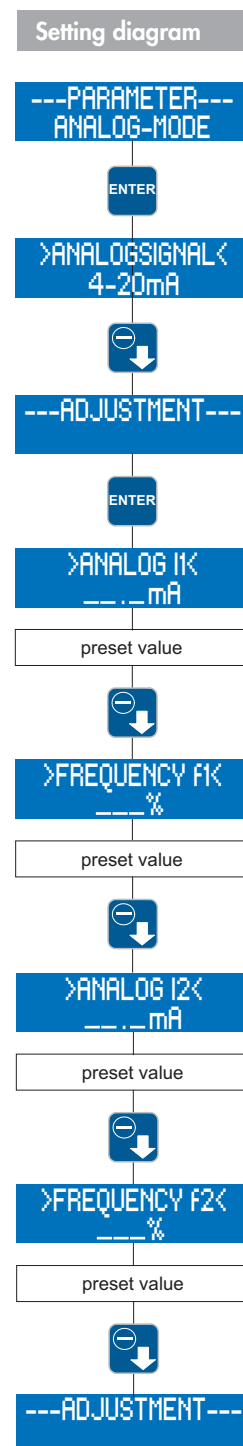

Additional settings for the PULSE mode

i NOTE

In order to be able to use the PULSE operation mode, at least one input must be assigned the PULSE function (see Chapter „Configuring the inputs and outputs“).
Input 01 (see Chapter „Control inputs and outputs“) is factory preset to pulse input (ANALOG 01).

Selecting the PULSE MODE

You can select among three different pulse modes:

- 1/1
Division
- Multiplication

In this mode, the pump performs exactly one stroke for each received pulse.



In this mode, a division of the received pulses is performed. This means that a stroke will only be performed after an adjustable number of pulses (division factor) has been received.



In this mode, a multiplication of the received pulses is performed. This means that the pump will perform an adjustable number of strokes (multiplication factor) after every received pulse.



Selecting the PULSE FACTOR

Depending on the selected pulse mode, the pulse factor corresponds either to the division factor or the multiplication factor.

The division factor can be selected between 1 and 999. If, for example, the division factor is 50, then the pump will perform a stroke only with every 50th received pulse.



The multiplication factor can be selected between 1 and 999. If, for example, the multiplication factor is 50, then the pump will perform 50 strokes with every received pulse.

For setting the pulse factor, please see the description in Chapter „Value entry“ (Assignment of values).



Switching ON/OFF the PULSE MEMORY

The pump is equipped with a pulse memory, which can optionally be switched ON and OFF. 999 strokes max can be saved. If the number of received pulses exceeds the number that can be handled by the pump, then the pulses will be buffered and the strokes will be performed later.

Example: With the setting 1:50, 5 pulses are in the memory perform. of 5 x 50 strokes = 250 strokes.

Connection of a pulse signal with External stop and response of the stroke signal:

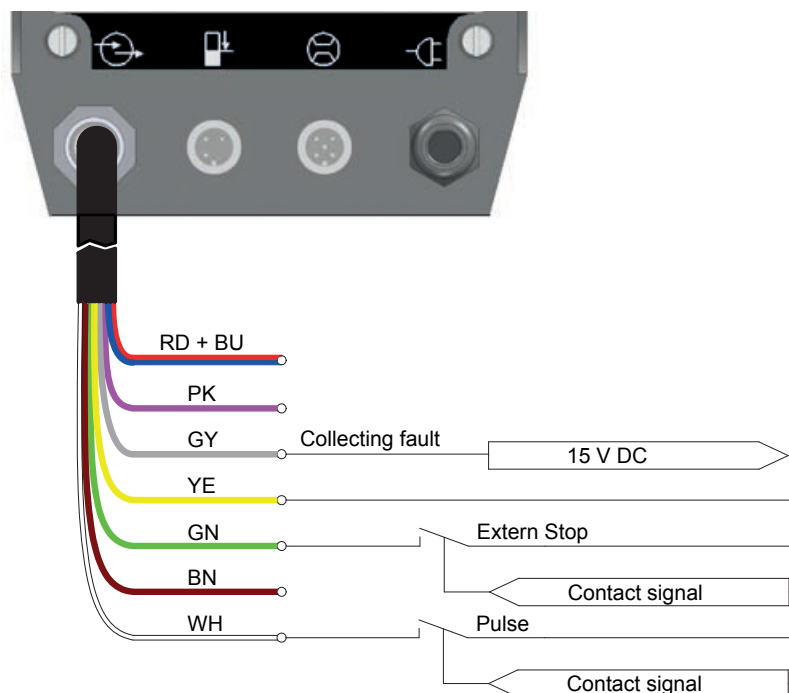

Additional settings for the BATCH mode

Selecting the type of CONTROL

You can select among three different types of control:

- MANUAL
- TIMER
- PULSE INPUT

With this type of control, the batch is started manually in the “operating messages” screen by pressing the ENTER key.



With this type of control, the batch is started daily at a fixed adjustable time (system time of the pump).



ATTENTION

The pump starts the batch when the preset time matches the system time of the pump. When the supply voltage is switched off, then the system time will be reset to 0:00.

ATTENTION

If the TIMER control is set, then the batch dosing will be repeated daily at the set time.

With this type of control, the batch is started via an external pulse at the pulse input.



i NOTE

In order to be able to use the PULSE INPUT control, at least one input must be assigned to the START BATCH function (see Chapter „Configuring the inputs and outputs“).

Determining the BATCH QUANTITY

The type of entry for the batch quantity depends on the calibration (see Chapter „Calibration“):

- Entry in strokes if the pump is not calibrated
- Entry in liters if the pump is calibrated

Adjusting the STROKE FREQUENCY

The stroke frequency at which the pump works during batch dosing can be adjusted. The value input is described in Chapter „Value entry“.

Determining the BATCH START

The pumps starts the batch dosing when the system time of the pump matches the value entered under BATCH START.

The value input is described in Chapter „Menu guide“.



i NOTE

In order to enable time-controlled batch dosing, TIMER control must be set under BATCH MODE.

Possible connector pin assignment in batch mode:

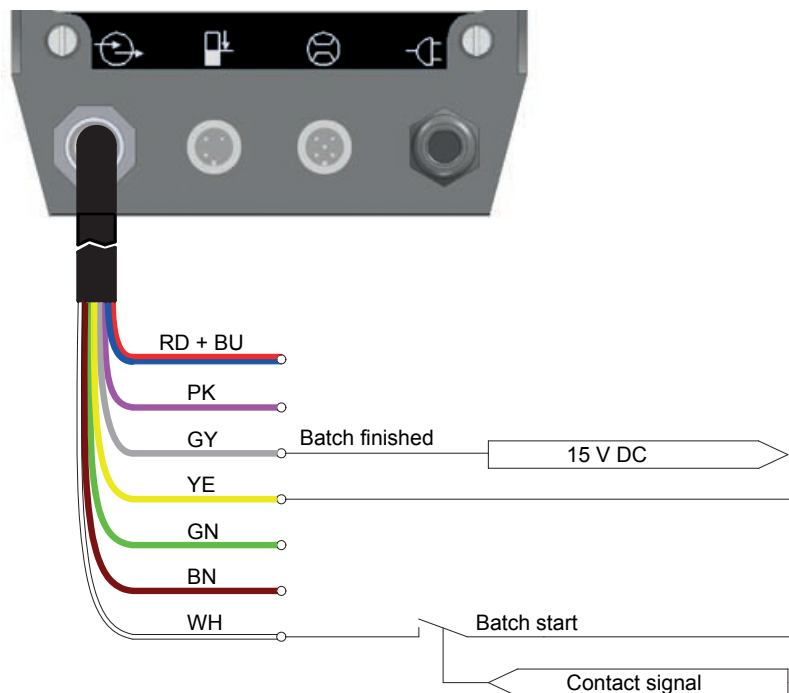

Settings for the EXTERNAL operation mode

i NOTE

In order to be able to use the EXTERNAL operation mode, at least one input must be assigned the EXTERNAL ON function (see Chapter „Configuring the inputs and outputs“).
Input 03 (see Chapter „Control inputs and outputs“) is factory preset to External ON.

In the EXTERNAL operation mode, only one stroke frequency (e.g. 63%) can be set.
As soon as an external ON signal is received, the pump will start running at this stroke frequency.
The value input is described in Chapter „Menu guide“.

>STROKE FREQ<
63 %

Possible connector pin assignment in External operation mode:

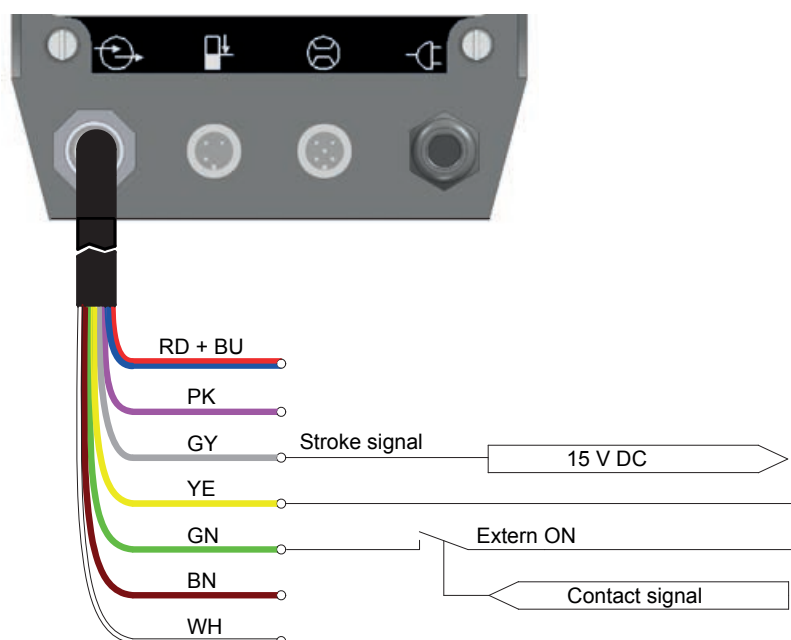

Configuring the inputs and outputs

The pump is equipped with three inputs and two outputs, which can be configured via a menu and thus be adapted to the given operating conditions.

It is possible to assign the same functions to all three inputs.

i NOTE

If several inputs are configured identically, then the input signals will be evaluated via OR-operation. This means that the function will be performed as soon as one of the inputs fulfils the condition.
Exception: Pulse input with pulse memory. If the pulse memory is switched on, then the received pulses will be summed up.

Go to the –MAIN MENU– and select the menu item IN-/OUTPUT (if necessary, use the UP / DOWN keys).
 Pressing the ENTER key opens the –IN-/OUTPUT– submenu.

Here, you can select among the individual inputs and outputs.
 Pressing the ENTER key opens the menu level for setting the individual inputs and outputs.

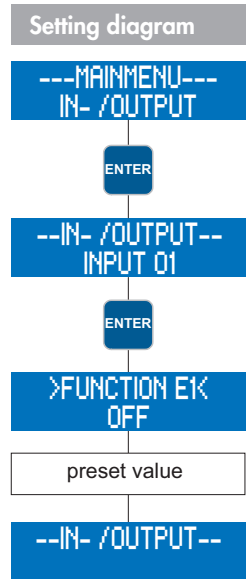

Digital input 01

Input 01 can be assigned one of six different functions. Optionally, it can also be switched off.

- Pulse
- External On
- External Stop
- Batch Start
- Analog 01/02
- OFF

In addition, it is possible to configure the contact signal of the input as NC or NO.

Configuration of the respective input as pulse input.

Function for externally switching on the pump via the respective input (only with the EXTERNAL operation mode).

Function for externally switching off the pump via the respective input (independent of the operation mode).



i NOTE

If the dosing pump is switched off via External Stop, then an "S" will be indicated in the 1. line of the display on the right-hand side:

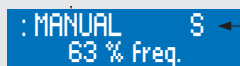

Function for externally starting the batch via the respective input.

>FUNCTION E1<
START BATCH

This function is used to switch over between the two analog inputs Analog 01 and Analog 02 (input 02 and 03) via input 01. Selection of the analog input is done in accordance with the following Table.

>FUNCTION E1<
ANALOG 01/02

Analog input switchover		
Configuration Contact E1	Applied signal	Selected analog input
NC	High	Analog 01 (input 02)
NC	Low	Analog 02 (input 03)
NO	High	Analog 02 (input 03)
NO	Low	Analog 01 (input 02)

The respective input is not assigned a function.

>FUNCTION E1<
OFF

Digital/analog inputs 02 and 03

Basically, input 02 and input 03 have the same functions as input 01 (see Chapter „Digital input 01“). In addition, they can also be used as analog inputs. However, the function “Analog 01/02”, which is used to switch over between the analog inputs is not available.

In addition, it is possible to configure the contact signals of the inputs as NC or NO.

The respective input is not assigned a function.

>FUNCTION E2<
ANALOG 01

bzw.

>FUNCTION E3<
ANALOG 02

Outputs 01 and 02

Each of the outputs 01 and 02 can be assigned one of ten different functions. Optionally, they can also be switched off.

- Ready to run
- Collective fault
- Collect. signal
- Stroke signal
- Pre-alarm level
- Dry run
- Diaphragm rupt. (only with option MBE!)
- Batch finished
- Internal error
- No flow
- OFF

In addition, it is possible to configure the contact signals of the outputs as NC or NO. Message from the respective output indicating the readiness of the dosing pump.

Message if one of the following faults occurs:

- Diaphragm rupture
- Dry run
- Internal error
- No flow (with DOSING STOP function)

>FUNCTION A1<
READY TO RUN

>FUNCTION A1<
COLLECTING FAULT

OPERATION

Message indicating that one of the following faults has occurred:

- All faults of the collective faults
- Pre-alarm level
- No flow (with MESSAGE function)

>FUNCTION A1<
COLLECT. SIGNAL

Message from the respective output indicating that a stroke has been performed.

>FUNCTION A1<
STROKE SIGNAL

With activated 2-stage level monitoring, message from the respective output indicating a pre-alarm.

>FUNCTION A1<
PRE-ALARM LEVEL

With activated level monitoring, message from the respective output indicating the dry run.

>FUNCTION A1<
DRY RUN

With activated diaphragm rupture monitoring, message from the respective output indicating a diaphragm rupture. (only with MBE option!)

>FUNCTION A1<
DIAPHRAGM RUPT.

With activated BATCH operation mode, message from the respective output indicating that the batch is finished.

>FUNCTION A1<
BATCH FINISHED

Signal when one of the following listed faults occurs (fault analysis/- causes see chapter „Analysis of the plain text error messages“):

- Fault drive
- Fault stroke sensor
- No stroke recognition
- Set value not attained

>FUNCTION A1<
INTERNAL ERROR

With activated flow control, message from the respective output indicating that the permitted number of fault strokes has been exceeded.

>FUNCTION A1<
NO FLOW

Flow rate indicator

i NOTE

If the dosing pump has not been calibrated, then the flow rate indicator will not be activated.

The flow rate indicator is activated via the calibration of the pump (see Chapter „Calibration“). The display depends on the operation mode:

MANUAL operation mode

After calibration of the dosing pump, the flow rate is entered directly as target value in l/h instead of via the stroke frequency adjustment. In the screen “operating messages” (see Chapter „Screen Operating messages“), the stroke frequency indicator is replaced by the flow rate indicator. In addition, the total dosing quantity is indicated in litres.

: MANUAL
7.2 l/h

: MANUAL
10.34 l

ANALOG operation mode

The calibration of the pump activates the flow rate indicator and the stroke frequency remains also visible. In addition, the total dosing quantity is indicated in litres.

: ANALOG
7.2 l/h

: ANALOG
10.34 l

BATCH operation mode

After calibration of the dosing pump, dosing quantity and remaining dosing quantity are indicated in litres.

: BATCH Man.
U 10.34 l

: BATCH Man.
R 10.34 l

PULSE operation mode

After calibration of the dosing pump, the total dosing quantity is also indicated in litres.

: PULSE
10.34 l

Standard flow rate indicator

With the standard flow rate indicator, the entered target value is converted into the corresponding stroke frequency. The maximum adjustable target value is limited by the internally determined stroke length.

Example:

The calibration at 50% stroke length results in a flow rate of 10l/h (at 100% stroke frequency). If a target value of 8l/h The maximum target value in this case is 10l/h. It can be changed via the stroke length adjustment (+/- 10%).

Internal calculation:

100% stroke frequency - Measure in litres: 10l/h

Target value: 8l/h - 80% stroke frequency

Flow rate indicator with flow meter

The flow meter records the actual value, and if the flow rate deviates from the entered target value, the dosing pump will readjust it.



ATTENTION

If the pump already works with 100% stroke frequency, there is no possibility of an additional capacity adjustment upwards. If the set value is fallen below, the warning signal "flow too low" appears".

The maximum adjustable target value is limited by the internally determined stroke length.

Example:

The calibration at 50% stroke length results in a delivery rate of 10l/h (at 100% stroke frequency). If a target value of 8l/h is entered, then the stroke frequency is at first accordingly reduced to 80%. The flow meter measures a delivery rate of 7.9l/h. The internal control increases the stroke frequency to 81% in order to achieve 8l/h.

The maximum target value in this case is 10l/h. It can be changed via the stroke length adjustment (+/- 10%).

Internal control:

100% stroke frequency - Measure in litres: 10l/h

Target value: 8l/h - 80% stroke frequency

80% stroke frequency - Actual value: 7.9l/h

8l/h - 81% stroke frequency

ATTENTION

In order to enable an effective capacity adjustment, pay attention that the given set value is attained when having a stroke frequency of < 100 %. A max. nominal stroke frequency of approx. 80 % is recommended in order to enable an adjustment of the capacity when the set value is fallen below.

NOTE

The set value in l/h can be preset manually (operating mode MANUAL) or by analog signal (ANALOG) as soon as the dosing pump is calibrated.

Calibration

The calibration is used to activate the flow rate indicator. Calibration is always done in the same way, no matter whether a flow meter is connected or not.

ATTENTION

Calibration is performed with a fixed stroke length. The calibration remains valid even if the stroke length is changed by up to +/- 10%. If this calibration range is exceeded, then the warning message "Out of range" will be displayed".

Sequence of calibration

ATTENTION

Prior to the calibration of the flow rate indicator with connected flow meter, the sensor type (>SENSOR<) must be set (see Chapter „SLOW-MODE“).
If no sensor type is set (OFF), then the calibration will only activate the standard flow rate indicator.

ATTENTION

Pay attention to the safety data sheet relating to the dosing medium!

Lead the suction line into a calibration pot filled with the dosing medium – the pressure line must be installed in final position, i.e. the operating conditions (backpressure, etc.) must be fulfilled.

When the suction line is empty the dosing medium must be drawn in (MANUAL operation mode, keep the pump running).

Set the stroke length with which the pump should be calibrated (can also be done via the manual stroke length adjustment)

Note the filling level in the calibration pot (= base quantity).

In der Ansicht Hauptmenue das Menü –KALIBRIERUNG– wählen:

Go to the main menu and select the –CALIBRATION–menu:

Press the ENTER key to access the field for entering the number of calibration strokes.

At first, enter the desired stroke number (at least 200!) the higher the stroke number the more accurate the calibration!

To start the calibration, press the ENTER key.

The dosing pump performs the preset number of strokes.

Determination of the pumped quantity
(= difference between base quantity and remaining quantity in the calibration pot).

Entry of the determined quantity.

Calibration of the dosing pump is then completed!

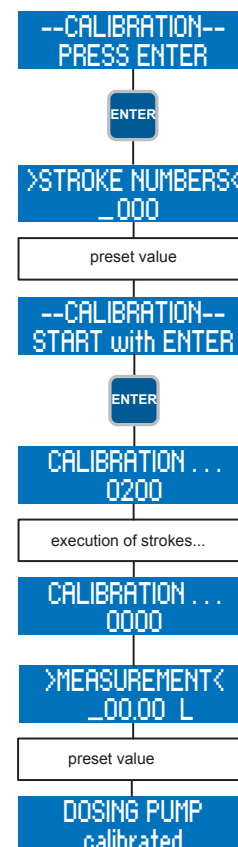

i NOTE

After the dosing pump has been calibrated, calibration (see Chapter „System“) will automatically be set to ON

⚠ ATTENTION

If the operating conditions are changed (supply line, backpressure, etc.), then the dosing pump must be newly calibrated. Otherwise, the flow rate indicator might be inaccurate!

System

The system settings do not depend on the operation mode. These include:

- Language
- Calibration
- Factory reset
- System time

>LANGUAGE<

You can select between GERMAN; ENGLISH and SPANISH menu texts.

>CALIBRATION<

The calibration of the pump (see Chapter „Calibration“) can be switched ON and OFF. If the calibration is set to ON and the dosing pump has been calibrated, then the flow rate indicator is activated.

If the calibration is set to OFF and/or the pump has not been calibrated, then the flow rate indicator is not activated.

>FACTORY RESET<

The factory settings (see Tab. „Overview of preset parameters“, Chapter „Parameter table“) can be restored. To do so, adjust YES.



ATTENTION

After restoring the factory default settings, all previous user-defined settings are irrevocably overwritten.

>SYSTEM TIME<

The system time must be adjusted manually.



ATTENTION

If the supply voltage is switched off, then the system time will be reset to 0:00. This means it must be set again.

Totalizer

The totalizer indicates the total quantity conveyed, the total strokes and the pump's operating hours. These values are for information purposes and cannot be reset.

Password

Two password levels are provided to increase the operating safety of the pump. The passwords for these levels consist of a four-digit number code and are individually selectable.

Password 01 (PW01) is used to protect the setting of the operation mode (Level 01). This password can be activated and deactivated (when leaving the factory, it is deactivated).

Password 02 (PW02) protects all further setting options of the main menu (Level 02, see "Menu guide"). This password protection cannot be deactivated.

i NOTE

If, during the 1. password request (Level 01), password 02 has been entered, then Level 02 is also automatically activated.

! ATTENTION

The passwords are factory set as follows:
Password 01: 9990 (deactivated)
Password 02: 9021 (cannot be deactivated!)

Go to the –MAIN MENU– and select the menu item PASSWORD.

Pressing the ENTER key opens the setting menu for the PW01 mode.

Press the DOWN key to access the setting for Password 01.

Value entry for Password 01 is enabled after pressing the ENTER key.

After having entered Password 01, press the DOWN key to access the setting for Password 02.

Value entry for Password 02 is enabled after pressing the ENTER key.

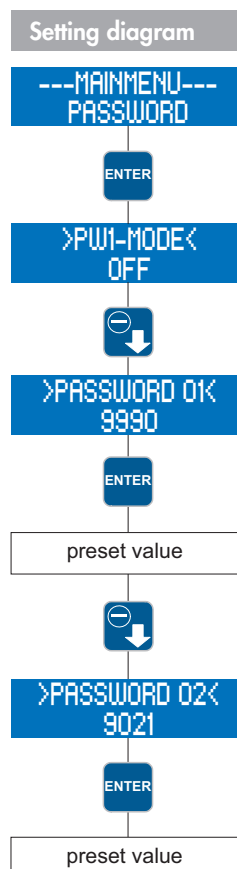

! ATTENTION

There is an automatic “Logout” after 5 min of inactivity in the “operation modes” screen. Afterwards, the password must be entered again.

! ATTENTION

Please write down the passwords and keep them in a safe place. When the passwords are lost the pump cannot be configured on site again.
 In this case, the pump must be sent to the manufacturer’s works for configuration release.

Info

The Info menu item contains information about the hardware and software version of the pump.

Extras

Slow-Mode (C410.2...)

In Slow Mode the pump is operated with reduced speed. This is, for example, reasonable for the feeding of very viscous media. Adjustments can be made to the following points:

---EXTRAS---
SLOW-MODE

SLOW-MODE
Speed

>SLOW-MODE<

Switching-on/Switching-off of the Slow Mode.

>SPEED<

Input of the speed when Slow Mode is activated. The speed can be set between 100 and 30 %.

NOTE

The entered speed in Slow Mode corresponds to the maximum stroke frequency the pump is operated. The maximal possible capacity is reduced correspondingly. The following is valid for the pulse and analog operation: Every stroke is performed with this speed.

Dosing monitoring

The connection of a sera flow controller to the dosing pump will enable the monitoring of the flow rate.

The connection of a sera flow meter to the dosing pump will provide a more detailed flow rate indication with regulation of the flow rate (see Chapter „Flow rate indicator“).

---EXTRAS---
DOSING MONITOR.

ATTENTION

Prior to the calibration of the flow rate indicator with connected flow meter, the sensor type (>SENSOR<) must be set. If no sensor type is set (OFF), then the sensor signal will not be considered during calibration.

It is possible to make adjustments to following items:

Sensor
Function
Fault stroke
Alarm limit
Calibration

>SENSOR<

Selection of the connected sera flow controller or sera flow meter.

>FUNCTION<

Selection of the dosing monitoring function. It can be selected whether the dosing monitoring should trigger a warning message (MESSAGE) or a switch-off of the pump (DOSING STOP).

>FAULT STROKE<

Number of fault strokes at which a connected flow controller triggers the dosing monitoring. The factory setting is 10 fault strokes. This means that the dosing monitoring will react if the flow controller does not give a stroke confirmation to the pump for the duration of ten consecutive strokes.

>ALARM LIMIT<

Alarm limit at which a connected flow meter triggers the dosing monitoring. The entered value corresponds to the percental part of the target flow rate. The factory setting is 80%. This means that the dosing monitoring will react if a connected flow meter measures a flow rate which is lower than 80% of the set target flow rate.

---CALIBRATION---

see Chapter „Calibration“.

Diaphragm rupture detection

The diaphragm rupture detection (see also Chapter „Diaphragm rupture monitoring device (option)“) is an optional feature for the dosing pump. It is used to monitor the diaphragm. It is possible to make adjustments to following items:

---EXTRAS---
DIAPHRAGM RUPT.

Input signal
Sensitivity

>INPUT SIGNAL<

Selection between switch-off (OFF) of the diaphragm rupture electrode and a configuration as NO or NC.

 **ATTENTION**

The contact type “switch normally closed” is to be set for conductive media when using single and double diaphragm pumps. When single diaphragm pumps are used the diaphragm rupture signalisation only functions with conductive media. The contact type “switch normally open” is for non-conductive media when using double diaphragm pumps with conductive buffer solution. The setting is ex works.

>SENSITIVITY<

Entry of the sensitivity of the diaphragm rupture electrode in percent. This enables an adaptation to the conductivity of the pumped medium. In case of poorly conductive media, the sensitivity must be set to a high value (e.g. 100% at approx. 4 μ S/cm); in case of highly conductive media, the sensitivity must be set to a low value (e.g. 10% at approx. 50 μ S/cm).

 **NOTE**

When leaving the factory, the sensitivity is preset to 50%. This corresponds to a minimum conductivity of the dosing medium of approx. 10 μ S/cm.
NOTE! The minimum conductivity at 100% sensitivity is 4 μ S/cm.

Level monitoring

The connection of a sera suction lance enables the monitoring of the filling level in the dosing tank:



- Pre-alarm
- Dry run

>PRE-ALARM< or >DRY RUN< respectively

Configuration of the two level inputs. It can be selected between either the switch-off (OFF) of the input and a configuration as NC (opening when floating down) or NO (closing when floating down).
When leaving the factory, both level inputs are configured as NO.

Configuration of the level input		
Configuration	Pre-alarm	Dry run
1	NO	NO
2	NO	NC
3	NC	NC

Configuration 1

When leaving the factory, this configuration is preset. A 1- or 2-stage level monitoring with “closing when floating down” contacts (pre-alarm and dry run or dry run only) can be connected.

Configuration 2

This configuration must be selected when a 1-stage level monitoring (dry run only) with “opening when floating down” contact is connected.

Configuration 3

This configuration must be selected when a 2-stage level monitoring with “opening when floating down” contacts (pre-alarm and dry run) is connected.

sera products are sophisticated technical products which are only shipped after having been thoroughly tested and checked at our factory. Should there be any faults, these can be detected and rectified easily and quickly based on the error messages in the display and the instructions in the tables.

Error message										Possible cause	Corrective action
No flow!	Flow rate too low!	Pulse memory full!	Analogue signal < 4 mA!	Analogue signal > 20 mA!	Analogue signal > 25 mA!	Mains voltage too low!	Mains voltage too high!	Time error!	Order wear parts kit!		
■	■					■	■			Electrical data of the dosing pump do not match mains data.	Check order data. Check electrical installation.
			■							Broken wire in the analogue signal line.	Check the analogue signal line and repair if necessary.
			■	■						Type of the specified analogue signal (e.g. 4-20 mA) does not match the actual analogue signal (e.g. 0-20 mA).	Check the specified analogue signal and adjust to the actual analogue signal if necessary.
			■	■	■					Analogue signal transmitter (sensor, regulator) has a fault.	Check the analogue signal transmitter and correct fault.
		■								Frequency of the incoming pulses is (constantly) higher than the maximum stroke frequency of the dosing pump.	Check process parameters.
		■								Pulse factor too high.	Check process parameters.
									■	Diaphragm has exceeded the maximum service life of one year or the maximum operating hours.	Contact sera and order diaphragm kit.
								■		Defective battery for the power supply of the real-time clock.	Contact sera .

FAULT ANALYSIS / FAULT CORRECTION

Error message						Possible cause	Corrective action	
Diaphragm rupture!	No flow!	Flow rate too low!	Pre-alarm level!	Dry running dosing pump!	No stroke detection!	Drive fault!		
■	■	■					Defective drive diaphragm.	Replace drive diaphragm.
	■	■			■		Suction height too high.	Reduce suction height or suction resistance.
	■	■					Suction pipe leaking.	Check seals, tighten pipe connections.
	■	■				■	shut-off valves in piping closed.	Open shut-off valves or check opening state – check pump for possible damage.
	■	■	■	■			Medium level in storage tank too low or no medium.	Fill storage tank.
	■	■					Pump valves leaking.	Remove and clean valves.
	■	■					Pump valves (ball seats) damaged.	Remove and clean valves, check function; replace valves if necessary.
	■	■					Pump valves incorrectly installed or valve balls missing.	Check installation position and completeness – replace missing parts or install correctly.
	■	■				■	Filter in suction line clogged.	Clean filter.
	■	■		■	■		Backpressure too high.	Measure pressure with manometer directly above pressure valve if possible and compare with permissible backpressure.
	■	■					Foreign matter in the pump valves.	Remove and clean valves.
	■	■				■	Acceleration height too high due to pipe geometry.	Check acceleration height on suction and pressure sides with manometer and compare with design data – install a pulsation damper if necessary.
	■	■			■	■	Viscosity of the pumped medium too high.	Check viscosity of the pumped medium and compare with design data – reduce concentration or increase temperature if necessary or install other pump valves.
	■	■					Pumped medium is outgassing in the suction pipe and/or the pump body.	Check geodetic conditions and compare with data of the pumped medium. Operate pump with suction side supply, reduce temperature of the pumped medium.
	■	■					Air in suction line while pressure is present on the pressure side.	Vent pressure side or open vent valve.
	■	■					Reversible thermal fuse of the pump has tripped.	Let temperature of the pump cool down. Check ambient temperature.
	■	■					Pipe connections leaking.	Tighten connections according to type of material. Be careful with plastic – risk of fracture!
	■	■			■	■	Pumped medium frozen in pipe.	Remove pump and check for possible damage - increase temperature of the pumped medium.
	■	■					Pump valves dry.	Moisten pump body and valves. Open vent valve.
					■	■	Sensors of the dosing pump defective.	Contact sera .

 **WARNING**

Observe and follow the safety instructions by all means.
See the additional instructions „SAFETY INSTRUCTIONS“.
Man, machine and environment are endangered if the safety instructions are not observed.



Maintenance and cleaning

The control is maintenance-free. Clean with a moist cloth. Rub dry afterwards.

Decommissioning

- Disconnect device from the power supply.
- Detach electrical connections.
- Take device out of operation.

Disposal

Dispose of correctly and comply with the currently applicable local regulations after shutdown and dismantling.

FOLLOW US



sera GmbH
sera-Str. 1
34376 Immenhausen
Germany
Tel. +49 5673 999 00
Fax +49 5673 999 01
info@sera-web.com

TM10-04 EN 10/2023. **sera** is a registered trademark by **sera GmbH**.
Subject to change without notice. **sera** accepts no liability for errors or misprints.