

PROFIBUS

CONTROL C410.2 / C204.1



i NOTE

Keep the operating manual for future use!

⚠ ATTENTION

Subject to technical modifications!

About this instructions

Special notes in these instructions are marked with text and danger symbols.

i NOTE

Notes or instructions that facilitate work and ensure a safe operation.

⚠ ATTENTION

The non-observance of these safety instructions can result in malfunctions or material damages.

⚠⚠ WARNING

The non-observance of these safety instructions can lead to material damages and personal injuries.

Quality notes

The **sera** quality management and quality assurance system is certified in accordance with DIN EN ISO 9001:2015. The **sera** product complies with the applicable safety requirements and accident prevention regulations.



Note on the additional instructions „SAFETY INSTRUCTIONS SI01“.

These technical manual is divided into the following main parts:

TRANSPORT & STORAGE	Page 6
ELECTRICAL CONNECTION	Page 7
OPERATION	Page 14
FAULT ANALYSIS / CORRECTIVE ACTION	Page 41

CONTENTS

TRANSPORT & STORAGE / AMBIENT CONDITIONS	6
General	6
Storage.....	6
Ambient conditions.....	6
Temperature data	6
ELECTRICAL CONNECTIONS	7
Electric supply C204.1	7
Electric supply C410.2	8
PROFIBUS Interface	10
Technical data PROFIBUS.....	10
Bus connection.....	10
Accessories for the bus connection	10
Pin assignment M12.....	11
Bus schema Master/Slaves.....	11
Stub cables	12
Bus cable.....	12
Level input with pre-alarm and dry run	13
Input for flow monitoring and flow measurement	13
Operating elements.....	14
OPERATION	14
LED operation indicators	15
Key operation	16
Parameter table	17
Menu	18
Operating messages	18
Display of operating messages	19
Operating messages dependent on the operating mode	19
Fault and warning messages	19
Main menu	20
Value entry	20
Menu guide.....	22
Selecting the operation mode	24
Operating the pump with Profibus-DP	25
Data flow from the master to the pump (slave).....	25
Control of the pump	26
Data flow from the pump (slave) to the master.....	27
Status message for the operation mode.....	27
Status of the pump.....	28
Status of dosing	28
Alarm messages of the pump.....	28
Pulse mode via the Profibus	29
Analog operation via Profibus	30
Analog operation with preset stroke frequency.....	30

Analog operation with preset desired flow rate	30
Batch mode via the Profibus	31
Batch mode with number of strokes	31
Batch mode with preset litres	31
External ON mode via the Profibus	32
Flow rate indicator	32
Calibration.....	34
System.....	35
Totalizer.....	36
Password	36
Info	37
Extras	37
Slow Mode (only C410.2)	37
Speed control (nur C410.2)	38
Dosing monitoring	38
Diaphragm rupture detection	39
Level monitoring.....	40
FAULT ANALYSIS/FAULT CORRECTION	41
Bus error messages	41

WARNING

Observe and follow the safety instructions by all means.
See the additional instructions „SAFETY INSTRUCTIONS“.
Man, machine and environment are endangered if the safety instructions are not observed.



General

sera products are checked for perfect condition and function previous to shipment.
Check for transport damage immediately after arrival of goods. If damage is found, this is to be reported immediately to the responsible carrier and the manufacturer.

Storage

An undamaged packaging protects the unit during storage and should only be opened when the product is installed.
Proper storage increases the service life of the product and includes prevention of negative influences such as heat, moisture, dust, chemicals etc.

The following storage specifications are to be observed:

- Storage place: cool, dry, dustfree and slightly ventilated
- Storage temperature and relative air humidity see Chapter „TECHNICAL DATA“.
- The maximum storage time for the standard packaging is 12 months.

If these values are exceeded, metal products should be sealed in foil and protected from condensation water with a suitable desiccant.

Do not store solvents, fuels, lubricants, chemicals, acids, disinfectants and similar in the storage room.

AMBIENT CONDITIONS

Max. relative humidity	< 90%
------------------------	-------

TEMPERATURE DATA

Max. operating temperature	40 °C
----------------------------	-------

Min. operating temperature	0 °C
----------------------------	------

Max. storage temperature	40 °C
--------------------------	-------

Min. storage temperature	0 °C
--------------------------	------

WARNING

Observe and follow the safety instructions by all means.
See the additional instructions „SAFETY INSTRUCTIONS“.
Man, machine and environment are endangered if the safety instructions are not observed.

**ATTENTION**

The electrical connection must be carried out by qualified personnel in accordance with local regulations!

ATTENTION

The pump restarts in the selected operating mode after the power supply was switched on or a power supply recovery following a mains failure!

ATTENTION

Switching the voltage supply on and off temporarily is to be avoided!

ATTENTION

Only operate the pump when it is connected to an earthed power supply!

Electric supply C204.1

The **sera** diaphragm pump C204.1 is delivered ready for installation. Standard delivery includes a 2m power cable with Euro plug. The standard version C 204.1 of the dosing pump is designed for an operating voltage range of 100 – 240V, 50/60Hz.

Symbol:

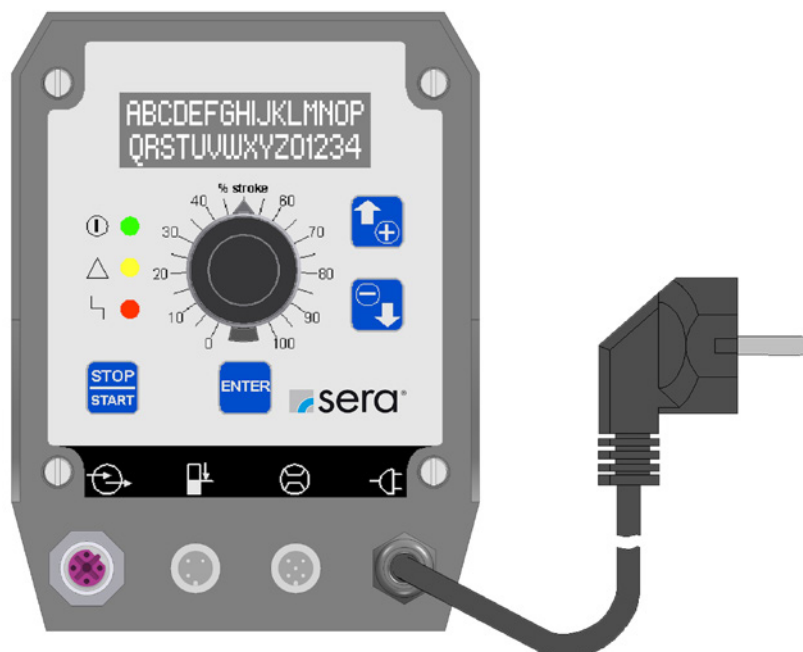
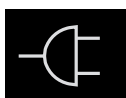

Electric supply C410.2

The sera diaphragm pump is delivered ready for connection with a 2m mains cable and a CEE-socket/16A 5-poles 6h. The diaphragm pump is designed for an operating voltage range of 380 – 420 V, 50/60 Hz.

Symbol:

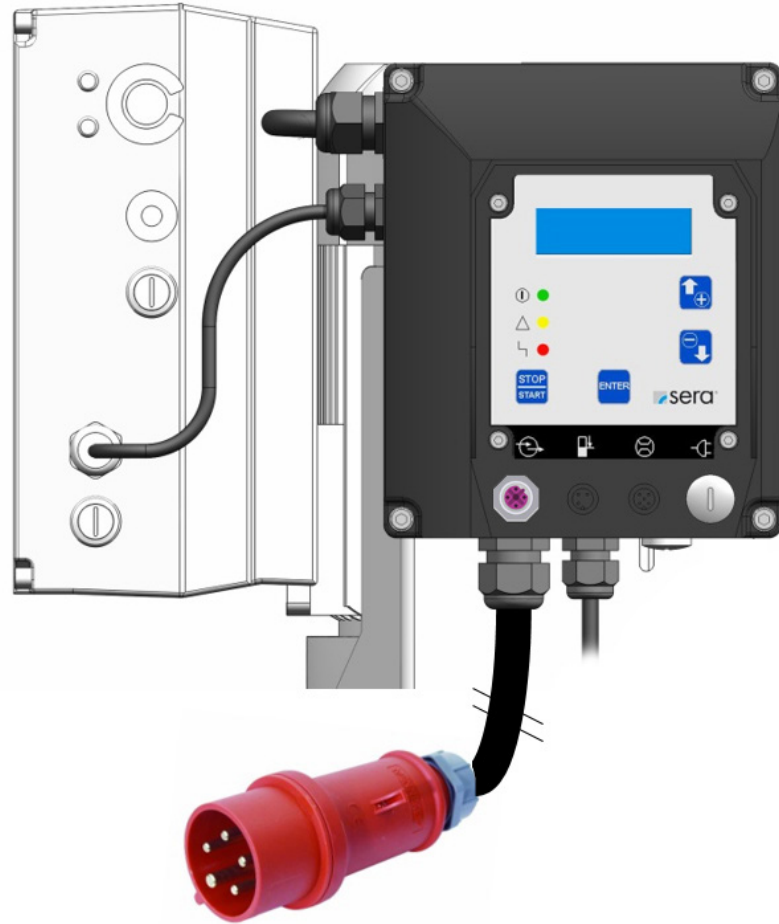

The mains connection requires 3~ 400V + neutral conductor + protective conductor.
The leakage current against earth amounts to approx. 7 mA.
Recommended protection: 3-poles automatic fuse C10A.

Connection mains pipe C410.2

ATTENTION

Activities of any kind should only be carried out by qualified employees!

ATTENTION

After the partition of the mains you have to wait at least 4 minutes before carry out work at the pump again!

- Open the electronic housing.

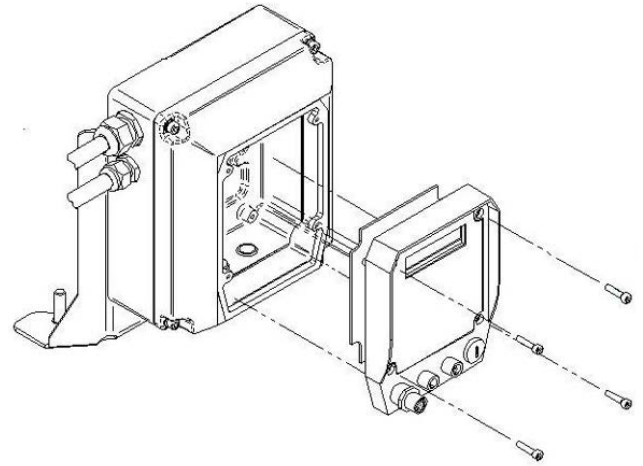

- Disengage the four hexagon socket screw keys for 3mm and
- pull the electronic forward carefully to get access to the mains connections on the reverse side.
- Tip the electronic softly forward but pay attention that meanwhile no other connections will be damaged or pulled out.

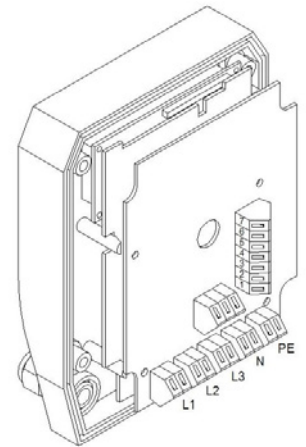

- Insert the mains pipe through the cable fitting M20 from below into the housing.

Core strip length: of 5 -6 mm
Cross section: of 1 -2,5 mm²

- For the connection to the cage clamp a screw driver with 3,5 x 0,5mm is required.
- Connect the three mains phases with the clamps L1, L2, L3.
- Connect the neutral conductor in N and the protective earth to PE.
- Afterwards fix the electronic back on the housing.
- The direction of rotation of the drive can not be changed by changing the phases.
- The direction of rotation of the drive is preset to anticlockwise rotation ex works.

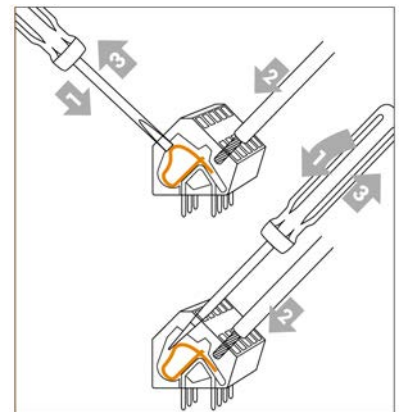

PROFIBUS Interface

The PROFIBUS DP interface replaces the conventional control modes by an analog or contact signal and allows for an unproblematic integration of the dosing pumps in complex systems of the process industry.

The user can choose between a manual control and PROFIBUS control of the pump. The known ANALOG, PULSE, EXTERNAL and BATCH modes are emulated via the PROFIBUS connection. These operating modes and specific parameters can be set at the bus connection.

Symbol:

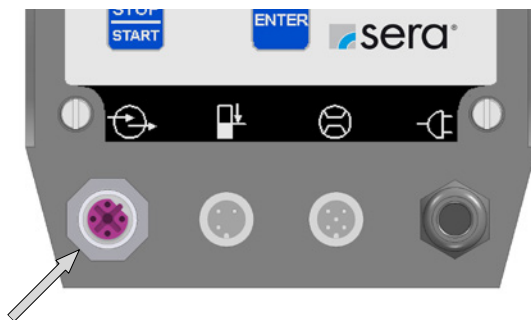

Connecting socket for PROFIBUS

Technical data PROFIBUS

PROFIBUS Interface:	■ PROFIBUS DP-V0 (Slave)
Transmission rate	■ 9.6/ 19.2/ 45.45/ 93.75/ 187.5/ 500 kbit/s ■ 1.5/ 3/ 6/ 12 Mbit/s ■ Automatic baud rate detection
Connection to dosing pump:	■ M12 socket B-coded

Bus connection

Connection to the Profibus at cable socket M12 B-coded via a double-wire Profibus cable. In addition a T- or a Y-piece is required (available as option). The first and the last subscriber within the bus segment must be provided with a terminating resistor. If the last subscriber is the pump, then a bus terminating resistor must be screwed onto the T- or Y-piece.

Accessories for the bus connection

<p>Y-Distributing piece</p> <p>Only a customer-assembled Profibus connector should be connected to the distributing piece.</p>	<p>cable plug connection to pump</p>		<p>cable socket signal output</p> <hr/> <p>cable plug signal input</p>
<p>T-Distributing piece</p>			
<p>Terminating resistor</p>			

Pin assignment M12

PIN-No.	Signal	Function
Pin 1	VP	+5V supply for bus termination
Pin 2	A-Line	negative RxD/TxD
Pin 3	GND Bus	data ground
Pin 4	B-Line	positive RXD/TxD
Pin 5	Shield	
Thread	–	connected to the shield via a Y/T distributing piece



ATTENTION

Die M12-Buchse ist invers codiert und besitzt 5 Stifte. Auf Stift 1 liegt 5V DC und auf Stift 3 liegt GND-Bus für den aktiven Abschlusswiderstand. Diese dürfen auf keinen Fall für andere Funktionen verwendet werden, da dies zu Zerstörung des Gerätes führen kann.

Stift 2 und Stift 4 führen die Daten der PROFIBUS-Kommunikation. Diese dürfen auf keinen Fall getauscht werden, da sonst die Kommunikation gestört ist. Stift 5 führt den Schirm (Shield), der intern nicht mit dem Modul verbunden ist.

Bus schema Master/Slaves

All devices are connected in a bus structure (line).

Up to 32 subscribers (master or slaves) can be networked within one segment.

The first and the last device must be provided with a terminating resistor.

The bus segments are connected to the total network with repeaters (amplifiers), but remain electrically isolated.

Up to maximum 126 subscribers (incl. repeaters) can be connected within the total network.

The bus subscribers are identified by the bus address. Each address must be unique and may only be assigned once.

i NOTE

The minimum cable length between the individual subscribers must be at least 1m for transmission rates of more than 1.5 Mbit/s. Note that the Profibus line does not run parallel with the live cables.

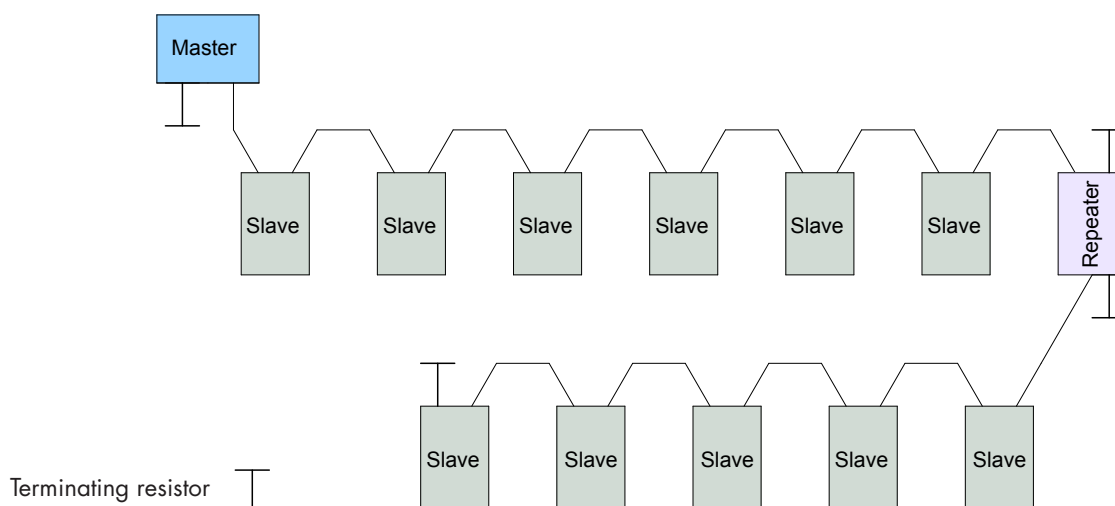

Stub cables

Stub cables (2) (with Y- or T-distributing piece) are branches from the main bus line (1) to the subscriber.

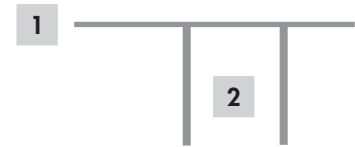

Stub cables are not allowed if the transmission rates exceed 1.5 Mbit/s. Stub cables may be used for transmission rates of less or equal 1.5 Mbit/s, if the limit values stated in the table are not exceeded.

Transmission rate	Total of stub cables *
> 1.5 Mbit/s	none
1.5 Ms	6.7 m
500 kbit/s	20 m
187.5 kbit/s	33 m
93.75 kbit/s	100 m
19.2 kbit/s	500 m

* Total of stub cables within a segment for PROFIBUS cable of 30 pF/m

The maximum cable length depends on the transmission rate. For transmission rates greater 1.5 Mbit/s a minimum cable length of 1m between two subscribers is recommended.

Transmission rate	Maximum cable length
> 1.5 Mbit/s	100 m
1.5 Mbit/s	200 m
500 kbit/s	400 m
187.5 kbit/s	1000 m
93.75 kbit/s	1200 m
45.45 kbit/s	1200 m
19.2 kbit/s	1200 m
9.6 kbit/s	1200 m

Bus cable

Cables with the following specifications should exclusively be used for new installations:

- Characteristic impedance 135...165 ohm (resistance for high-frequency signals)
- Capacitance per unit length < 30 pF/m
- Loop resistance 110 ohm/km
- Lead diameter 0.64 mm
- Lead cross section > 0.34 mm²

Level input with pre-alarm and dry run

i NOTE

Pre-alarm and dry run are connected to the same jack.
When leaving the factory, both inputs are preset to "closing when floating down", normally open (NO).
However, if necessary, they can be freely configured

Symbol:

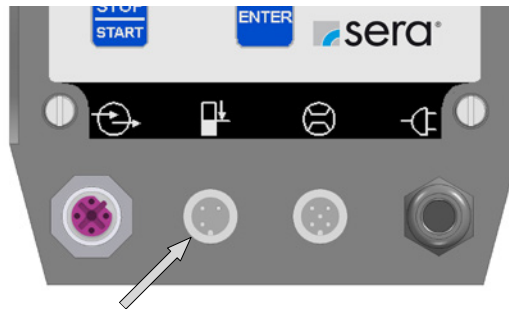

Connection socket for the level input

Input for flow monitoring and flow measurement

⚠ ATTENTION

Only flow monitors and flow meters made by **sera** may be connected to the dosing pump.
If you use other than **sera** products, the electronics might get damaged.

Symbol:

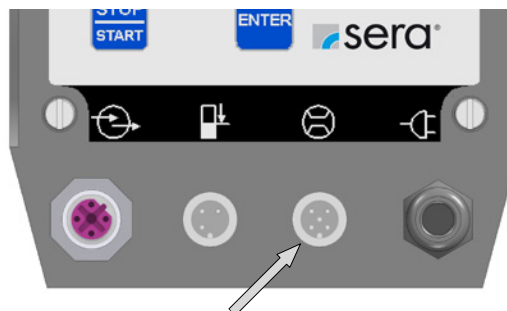

Socket for flow monitoring/
flow measurement

sera flow monitors and flow meters are delivered completely with cable and plug.
Electrical connection is made directly to the 5-pole socket.

WARNING

Observe and follow the safety instructions by all means. See the additional instructions „SAFETY INSTRUCTIONS“. Man, machine and environment are endangered if the safety instructions are not observed.





Operating elements





1	STOP/START-Button	5	DOWN-Button
2	LED-Indication	6	ENTER-Button
3	LCD-Display	7	Stroke length adjustment
4	UP-Button		

LED operation indicators

Three light-emitting diodes (LED) indicate the status of the pump.

Green: Operation and stroke indicator	
	When switching on the pump, the green LED lights permanently. The operation indicator works in combination with a stroke indicator; during pump operation, the LED flashes depending on the current stroke frequency.
Yellow: Warning indicator	
	The yellow LED indicates all occurring warning messages (see table). The warning is not only indicated by the LED but also as plain text in the LCD display.
Red: Fault indicator	
	The red LED indicates all occurring faults (see table). The fault is not only indicated by the LED but also as plain text in the LCD display.



Overview LED operation indicators	green LED	yellow LED	red LED
			
Ready	ON		
Confirmation of stroke	flashing		
Internal error			ON
Mains voltage too low/too high		ON	
No mains			
Level monitoring			
Pre-alarm level		flashing	
Dry run			flashing
Dosing monitoring (flow monitor or flow meter)			
No flow - with warning message		ON	
No flow - with shut-down			ON
Flow too low - with warning message		ON	
Flow too low - with shut-down			ON
Diaphragm rupture monitoring			
Diaphragm rupture			ON
Profibus			
Bus offline			ON
Error bus module			ON
Bus fail safe		ON	

NOTE

The “dry run” fault message suppresses the “pre-alarm” warning. This means that if the pump runs dry while the 2-stage level monitoring is activated, then only the red LED will flash.

Key operation

Operation of the pump is performed with four Buttons:

STOP/START Button	
	After connection to the power supply, the pump is switched ON/OFF using the STOP/START button.
ENTER Button	
	You can use the ENTER key to open and confirm value input fields and to select menu items
UP-/DOWN Button	
	Using the UP/DOWN key, you can scroll the different menu items/menu levels and select the display of various operating messages. During parameter adjustment, the UP key is used to increase the parameter value and the DOWN key is used to decrease the parameter value.

Parameter table

The factory settings of the controlled diaphragm pump are specified in the following table. Adaptation of the settings to specific applications and dosing jobs is facilitated by references to the corresponding chapters.

In addition the parameter table allows to document any changes of the settings made so that the current settings of each pump are always available.

Overview of set parameters

Dosing monitoring		Seite 38
Sensor	OFF	
Function	Message	
Fault strokes	10	
Alarm limit	80 %	
Level		Seite 46
Pre-alarm	NO (normally open)	
Dry run	NO (normally open)	
System		Seite 42
Language	german	
Calibration	OFF	
Profibus address	20	
SLOW-Mode ⁽¹⁾		Seite 44
SLOW-Mode ⁽¹⁾	OFF	
Speed ⁽¹⁾	80%	
Speed control ⁽¹⁾	AUTO	
Password		Seite 42
PW01 mode	OFF	
Password 01	9990	
Password 02	9021	
Diaphragm rupture		Seite 39
Input signal	NO (normally open)	
Sensitivity	50%	

⁽¹⁾ only with C410.2

Menu

You can switch between the following three views:

- Operating messages
- Main Menu
- Fault and warning messages

A change to the view "Fault and warning messages" is only possible when a fault or warning is present.

A change between the "Operating messages" and "Main menu" views is done by simultaneously pressing the UP and DOWN keys.

A change between the "Operating messages" and "Fault and warning messages" views is done by simultaneously pressing the ENTER and DOWN keys.

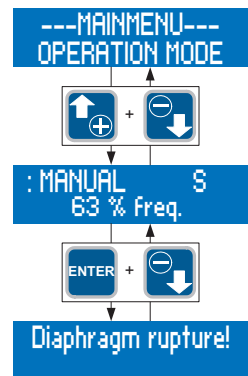

i NOTE

After, in the main menu, no key has been pressed for 3 min. the "Operating messages" view is automatically called.

Operating messages

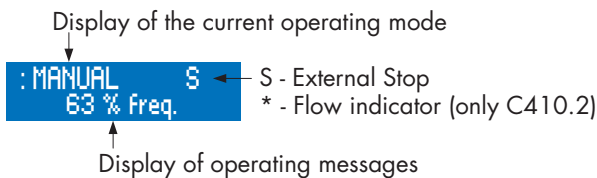

Display of the current operating mode

The first line in the "Operating messages" view shows the currently set operating mode.

Flow indicator (only 410.2)

A star symbol (*) in the first line on the righthand side is used as flow indicator. The star symbol indicates the response of a connected dose monitor (flow monitor or flow meter)

i NOTE

The flow indicator (*) is only active when a flow monitor/flow meter is connected and the dose monitor is activated (only with C410.2).

Display of operating messages

The second line of the display shows, dependent on the set operating mode, a variety of operating messages (e.g. the current stroke frequency, total strokes – see table). The operating messages can be scrolled using the UP and DOWN buttons.

You can use the ENTER button to open the value input fields of the editable operating messages.

Operating messages dependent on the operating mode

Operating messages	Operating mode				
	Manual	Analog	Pulse	Batch	External
Current stroke frequency	<input type="radio"/> ⁽¹⁾	<input checked="" type="radio"/>	<input checked="" type="radio"/>	<input checked="" type="radio"/>	<input checked="" type="radio"/>
Current dosing performance ⁽²⁾	<input type="radio"/>	<input checked="" type="radio"/>			
Total strokes	<input type="radio"/>	<input checked="" type="radio"/>	<input checked="" type="radio"/>	<input checked="" type="radio"/>	<input checked="" type="radio"/>
Total dosing quantity ⁽²⁾	<input type="radio"/>	<input checked="" type="radio"/>	<input checked="" type="radio"/>	<input checked="" type="radio"/>	<input checked="" type="radio"/>
Pulse factor			<input checked="" type="radio"/>		
Memory			<input checked="" type="radio"/>		
Dosing quantity/strokes				<input checked="" type="radio"/>	
Remaining dosing quantity/remaining strokes				<input checked="" type="radio"/>	

= Display

= Display and adjustment

⁽¹⁾ = not with calibrated pump

⁽²⁾ = only with calibrated pump

Fault and warning messages

When a fault or warning has occurred, the dosing pump shows a message in plain text format on the LCD display

i NOTE

The message disappears automatically when the cause of the fault or warning has been removed.

Main menu

The upper line shows the superordinate menu items or editable parameters. The lower line shows the subordinate menu items or selectable values and settings.

Superordinate menu items are marked with “-” . Superordinate means that no values or settings can be assigned to this item.

Parameters which can be assigned different values or settings are marked with “>” and “<” . Each parameter should be assigned a definitive value or setting.

The >PROFIBUS ADR.< parameter can, for example, be assigned the value 20.

Value entry

The assignment of values and settings to a parameter is described in the following, using two exemplary illustrations.

Assignment of settings

- Display of the current setting (here: MANUAL operating mode).
- Value entry is enabled after pressing the ENTER button.
- Then, the operating mode indicator flashes and a setting can be selected (here: operating modes) using the UP and DOWN buttons.
- After a setting has been selected (here: PROFIBUS mode), pressing the ENTER button will confirm and save the choice.
- Display of the current setting (here: Operation mode PROFIBUS).

Example of a display with superordinate menu items



Example of a display with parameters



PROCEDURE



Assignment of values

- Display of the current value (here: 40)
- value entry is enabled after pressing the ENTER button
- the first digit of the value flashes
- the desired figure can be set using the UP and DOWN buttons (here: 2)
- after having selected the desired digit, pressing the ENTER button will confirm the choice
- the second digit starts to flash
- the desired figure can be set using the UP and DOWN buttons (here: 4)
- after having selected the desired digit, pressing the ENTER button will confirm the choice afterwards, the entered value will be saved
- display of the current value (here: Profibus address 24).

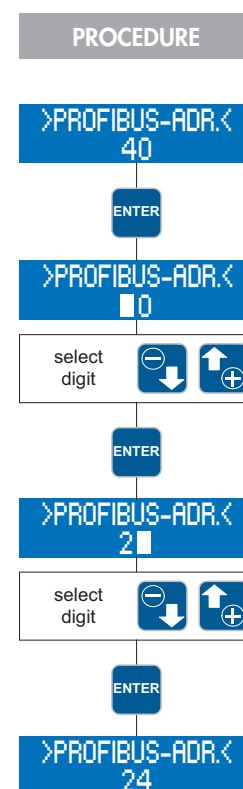

The value entry (flashing indication) can be exited by simultaneously pressing the UP and DOWN buttons. In this case, the previous value/previous setting will be maintained.

i NOTE

If, during the value entry (flashing indication), no button has been pressed for 30 sec. the entry mode is exited automatically and the previous value/previous setting is maintained.

Menu guide

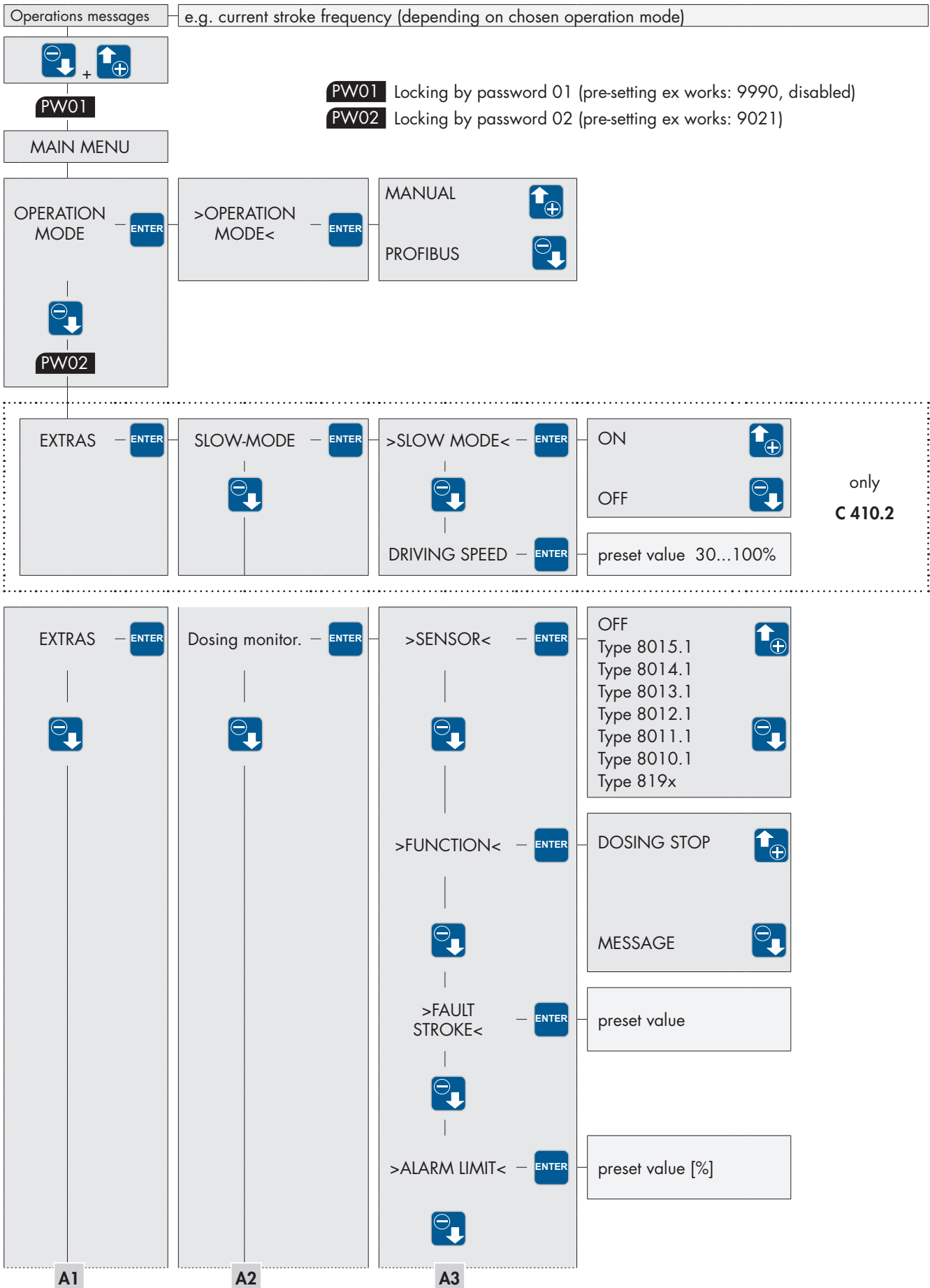

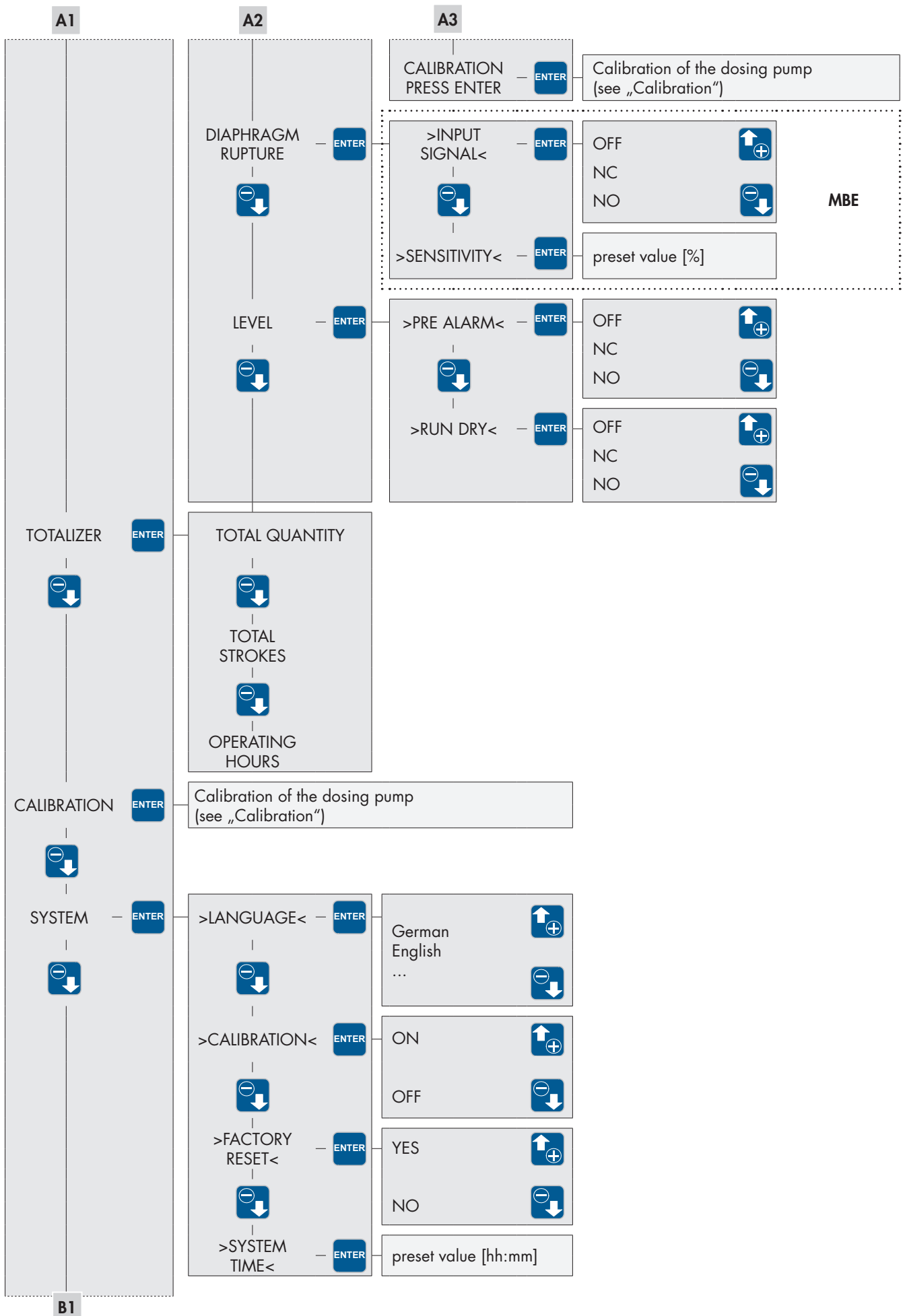

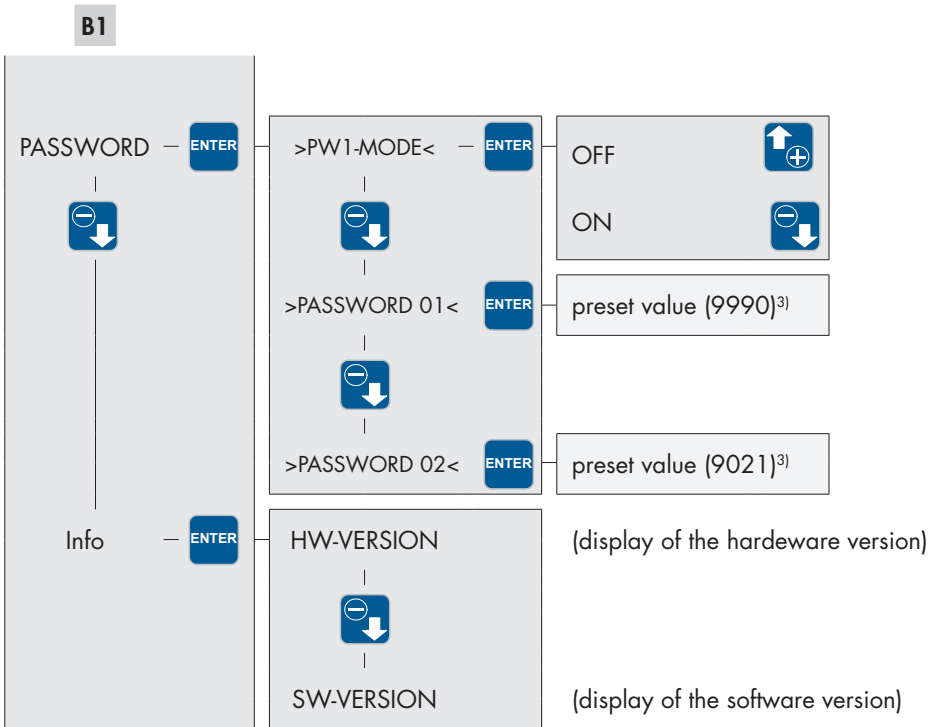

³⁾ pre-setting ex works

Selecting the operation mode

You can select among two different operating modes:

- MANUAL
- PROFIBUS

>OPERATION MODE<
MANUAL

On-site operation and on-site control of the pump without external control. The flow rate can be set via the manual stroke length adjustment and/or by presetting a stroke frequency. With a calibrated pump, the flow rate is set in l/h instead of via the stroke frequency.

i NOTE

There are no setting possibilities in the main menu for the MANUAL operating mode

>OPERATION MODE<
PROFIBUS

- Go to the MAIN MENU and select the menu item OPERATION MODE (use the UP/DOWN buttons)
- pressing the ENTER button will open the >OPERATION MODE< submenu
- the currently set operating mode is indicated (here: MANUAL)

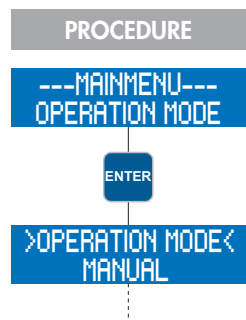

The adjustment of an operating mode is done in accordance with the description in Chapter „value entry“.

Operating the pump with Profibus-DP

The control via Profibus is activated in the main menu in the "Operation mode" parameter. In addition the Profibus address of the dosing pump must be set. You will find this parameter under the "System" menu item. The dosing pump will start again automatically and the new address will be retrieved after the address was changed. In this control mode the Profibus master (e.g. PLC) will send commands to the slaves (e.g. the pump). The pump will then execute the control signals of the master. The following operating modes are available for this control mode:

- PULSE
- ANALOG
- BATCH
- EXTERNAL ON

Depending on the Profibus master and the visualization software the control of the pump can be different.

Data flow from the master to the pump (slave)

Nine bytes are available for controlling the dosing pump.

Byte	Data type	Data length [byte]
1	Byte	1
2	Byte	1
3, 4	Unsigned 16	2
5	Byte	1
6	Byte	1
7	Byte	1
8, 9	Unsigned 16	2

Setting the operation mode

Bit	Byte 1	Settings for the operation mode		
0, 1, 2	Bit 2	Bit 1	Bit 0	Operation mode
	0	0	0	No selection*
	0	0	1	Pulse
	0	1	0	Analog
	0	1	1	Batch
	1	0	0	External ON
	1	0	1	inadmissible*
1	1	0	inadmissible*	
1	1	1	1	inadmissible*
3, 4		Bit 4	Bit 3	Reserve
5,6		Bit 5	Bit 6	Pulse mode
		0	0	Reduction
		0	1	1:1
		1	0	Transmission
	1	1	1	Transmission
7			Bit 6	Pulse memory
			0	OFF
			1	ON

* Pump goes into fail-safe mode (safe condition)

Control of the pump

Bit	Byte 2	Control
0	1 = Pulse	Pulse input for pulse mode. If the rising edge is 0 -> 1 a stroke will be executed.
1	1 = ON	External ON Operation
2	1 = STOP	External Stop, applies to all operating modes apart from manual mode.
3	Reserve	
4	1 = START	If the rising edge is 0 -> 1 a batch will be executed..
5 ¹⁾	0 = Single stroke ¹⁾ 1 = Automatic ¹⁾	Single stroke means that the speed controller is OFF. Automatic means that the speed controller is ON. Single stroke operation with 30% speed will be activated if the stroke frequency is less than 30%.
6 ¹⁾	1 = Slow Mode ¹⁾	Speed limitation
7	1 = Reset	Reset the alarm message. If the rising edge is 0 -> 1 a reset will be executed.

¹⁾ only with C410.2 (with C204.1 = Reserve)

The preset values depend on the operating mode selected

Byte 3, 4 The function depends on the operating mode		
Operation mode	Dosing pump calibrated	Value
Pulse	No	Factor
Analog	No	Stroke frequency in %
Analog	Yes	Desired flow rate in l/h ²⁾
Batch	No	Number of strokes
Batch	Yes	Batch volume in Liter ²⁾
External	Yes/No	Stroke frequency in %

²⁾ Decimal digit depends on byte 7 data flow from pump to master

Presetting the stroke frequency for the Batch mode

Byte 5
Stroke frequency for Batch mode in %. preset value from 30 to 100.

Presetting the stroke frequency for the Slow mode (only C410.2)

Byte 6
Stroke frequency for Slow mode in %. preset value from 30 to 100.

Control of the internal counter

Bit	Byte 7	Control of the counter
0	1 = Reset	Resetting the counter "Data flow from the pump (slave) to the master, bytes 9, 10". The counter is kept at zero as long as the bit = 1.
1	1 = Hold	Counter Hold "Data flow from the pump (slave) to the master, bytes 9, 10" The initial counter value is maintained as long as the bit = 1. The internal counter keeps on counting.
2 - 7	Reserve	

Reserve

Byte 8, 9	Reserve
	Reserve

Data flow from the pump (slave) to the master

12 bytes are available for the messages from the dosing pump to the control system

Byte	Data type	Data length [Byte]
1	Byte	1
2	Byte	1
3, 4	Unsigned 16	2
5	Byte	1
6	Byte	1
7	Byte	1
8	Byte	2
9, 10	Unsigned 16	1
11, 12	Unsigned 16	2

Status message for the operation mode

Bit	Byte 1	Status operation mode		
0, 1, 2	Bit 2	Bit 1	Bit 0	Operation mode
		0	0	No selection, pump is in the Fail Safe mode
		0	1	Pulse
		0	1	Analog
		0	1	Batch
3, 4		1	0	External ON
		Bit 4	Bit 3	Reserve
		Bit 6	Bit 5	Pulse mode
		0	0	Reduction
5,6		0	1	1:1
		1	0	Transmission
		1	1	Transmission
7		Bit 7		Pump calibrated
		0		NO
		1		YES

Status of the pump

Bit	Byte 2	Status pump
0	1 = Online	Pump is switched on (online, green LED lights up)
1	1 = Stroke signal	Dosing stroke is executed. The signal is applied for 200ms.
2	1 = Batch finished	Batch finished. The signal is reset to 0 when a new batch is started.
3	Reserve	
4	1 = BUS mode 0 = Manual mode	Profibus mode activated Manual mode activated
5	0 = Confirmation	Reset is confirmed. Bit is 1 as long as the Re-set bit (byte 2/bit 7 from the master to the pump) is set.
6	1 = Collective message	All alarms and trips are integrated in the collective message.
7	1 = Collective fault	All trips which result in the pump being switched off are integrated in the collective fault.

Status of dosing

Byte 3, 4		Status of dosing	
Operation mode	Dosing pump calibrated	Flow meter connected	Value
Pulse	no	not relevant	Factor
Analog	no	not relevant	Stroke frequency in %
Analog	yes	no	Desired flow rate in l/h ¹⁾
Analog	yes	yes	Actual flow rate in l/h ¹⁾
Batch	no	not relevant	Number of remaining strokes
Batch	yes	not relevant	Remaining flow rate in Liter ¹⁾
External	yes/no	not relevant	Stroke frequency in %

¹⁾ Decimal digit depends on byte 7 data flow from the pump to the master

Alarm messages of the pump

Bit	Byte 5	Alarm byte 01
0	1 = Fault	fault drive
1	1 = Fault	Out of calibration mode
2	1 = Fault	Desired value cannot be achieved
3	1 = Fault	Fault stroke sensor
4	1 = Fault	No reply from stroke sensor
5		Reserve
6	1 = Fault	Drive too slow ²⁾
7	1 (always)	Reserve

²⁾ only with C410.2 (with C204.1 = Reserve)

Bit	Byte 6	Alarm byte 02
0	1 = Fault	Diaphragm rupture
1	1 = Pre-alarm	Pre-alarm level
2	1 = Dry run	Dry run level
3	1 = Fault	Mains voltage too high
4	1 = Fault	Mains voltage too low
5	1 = No flow	Only active when the flow monitor is activated.
6	1 = Fault	Flow too low, only active with connected flow meter
7	1 = Overflow	Overflow of pulse memory, too many input pulses

Decimal points for the status of dosing and preset values

Byte 7	Factor for the values
Power for bytes 3, 4 from the pump to the master	
Value = 0	$\rightarrow 10^0 \Rightarrow$ no decimal digit
Value = 1	$\rightarrow 10^1 \Rightarrow$ one decimal digit
Value = 0	$\rightarrow 10^2 \Rightarrow$ two decimal digits
Value = 0	$\rightarrow 10^3 \Rightarrow$ three decimal digits
...	
Power for bytes 3, 4 from the master to the pump	

Decimal digits for the counter

Byte 8	Factor for the values
Power for bytes 9, 10 status volume counter from the pump to the master	

Status internal counter

Byte 9, 10	Factor for the values
Dosing pump calibrated	Value
No	Stroke counter
Yes	Volume counter in Liter

RESERVE

Byte 11, 12	Reserve
Reserve	

Pulse mode via the Profibus

In this operating mode the pump is controlled via a pulse from the Profibus. The reduction/transmission and the pulse memory can also be set. The pump will then execute one dosing stroke depending on the mode selected.

Data from the master to the pump

Adjustment of the operating mode

- Byte 1 = 21h (pulse mode 1:1, pulse memory OFF)
- Byte 1 = A1h (pulse mode 1:1, pulse memory ON)
- Byte 1 = C1h (pulse mode transmission, pulse memory ON)
- Byte 3,4 = 2h (pulse factor 2) two dosing strokes will be executed at one input pulse

Pulse execution:

- Byte 2 / Bit 0. A pulse will be triggered during a change from 0 \rightarrow 1

The pump will then execute one dosing stroke depending on the mode selected

i NOTE

The maximum pulse frequency depends on the transmission rate, the program runtime of the master and the number or Profibus subscribers.

Analog operation via Profibus

In analog mode the stroke frequency of the pump is controlled via the Profibus. In case of a calibrated pump the desired value is set in l/h. The decimal points of the value are indicated in byte 7 in the data range from the pump to the master.

Analog operation with preset stroke frequency

Data from the master to the pump

Adjusting the operating mode and the stroke frequency:

- Byte 1 = 2h (analog mode)
- Byte 3,4 = 0..100 stroke frequency in %

In addition the pump can be stopped with:

- Byte 2 = 4h via the Profibus

Analog operation with preset desired flow rate

i NOTE

h = hexadecimal number

Data from the master to the pump

Adjusting the operating mode and the desired flow rate:

- Byte 1 = 2h (analog mode)
- Byte 3,4 = desired flow rate in l/h

The speed control is set by:

- Byte 2 / Bit 5.
 - Bit 5 = 0, speed control OFF (single stroke mode)
 - Bit 5 = 1, speed control ON, below a stroke frequency of 30% single stroke operation with 30% speed will be activated.

In addition the pump can be stopped with:

- Byte 2/ Bit 2 = 1 via the Profibus.

Data from the pump to the master

- Byte 7 = Power (decimal point for desired flow rate)

Example:

Byte 7 / power = 1 → 10^1 = one decimal digit

The desired flow rate has one decimal digit.

e.g. 12.5 l/h, the value to be transmitted to the pump in bytes 3, 4 is then 125.

Batch mode via the Profibus

In this operating mode dosing is executed per batch.
The batch value can be set as the number of strokes or – in case of a calibrated pump – as the volume in litres.

Batch mode with number of strokes

i NOTE

h = hexadecimal number

Data from the master to the pump

Settings for the operating mode:

- Byte 1 = 3h (batch mode)
- Byte 3,4 = number of strokes
- Byte 5 = max. stroke frequency in %

Start of the batch with:

- Byte 2 = Ah

Data from the pump to the master

- Byte 2 / Bit 2 = 1 = Batch finished.

Batch mode with preset litres

i NOTE

h = hexadecimal number

Data from the master to the pump

Settings for the operating mode:

- Byte 1 = 3h (batch mode)
- Byte 3,4 = batch volume in l
- Byte 5 = max. stroke frequency in %

Start of the batch with:

- Byte 2 = Ah

Data from the pump to the master

- Byte 7 = power (decimal digit for the batch volume)

Example:

Byte 7 / power = 1 → 10^1 = one decimal digit

The batch volume has one decimal digit.

e.g. 3.5 l/h → the value to be transmitted to the pump in bytes 3, 4 is then 35.

- Byte 2 / Bit 2 = 1 = batch finished.

External ON mode via the Profibus

i NOTE

h = hexadecimal number

In external operating mode the pump continues to run with a preset stroke frequency as long as the external signal via the Profibus is applied.

Data from the master to the pump

Adjusting the operating mode and the stroke frequency:

- Byte 1 = 4h (external mode)
- Byte 3,4 = stroke frequency in %

External ON with:

- Byte 2 = 2h

Flow rate indicator

i NOTE

If the pump has not been calibrated, then the flow rate indicator will not be activated.

The flow rate indicator is activated after the pump was calibrated.
The values displayed are dependent on the operating mode:

MANUAL operating mode

: MANUAL
7.2 l/h

: MANUAL
10.34 l

After calibration of the dosing pump, the flow rate will be entered directly as desired value in l/h instead of via the stroke frequency adjustment. In the "Operating messages" screen the stroke frequency display is replaced with the flow rate display. In addition, the total dosing volume is indicated in litres.

PROFIBUS/ANALOG operating mode

: ANALOG
7.2 l/h

: ANALOG
10.34 l

The calibration of the pump activates the flow rate indicator and the stroke frequency remains also visible. In addition, the total dosing volume is indicated in litres.

PROFIBUS/BATCH operating mode

: BATCH Man.
V 10.34 l

: BATCH Man.
R 10.34 l

After calibration of the dosing pump, the dosing volume and the remaining dosing volume are indicated in litres

PROFIBUS/PULSE operating mode

: PULSE
10.34 l

After calibration of the dosing pump, the total dosing volume is also indicated in litres

Standard flow rate indicator

With the standard flow rate indicator, the entered desired value is converted into the corresponding stroke frequency. The maximum adjustable desired value is limited by the internally determined stroke length.

Example:

The calibration at 50% stroke length results in a flow rate of 10l/h (at 100% stroke frequency).

If a desired value of 8l/h is entered, then the stroke frequency is accordingly reduced to 80%.

The maximum desired value in this case is 10l/h.

It can be changed via the stroke length adjustment (+/- 10%).

internal calculation:

100 % stroke frequency → Measured in litres: 10l/h

Desired value: 8 l/h → 80 % stroke frequency

Flow rate indicator with flow meter

The flow meter records the actual value, and if the flow rate deviates from the entered desired value, the dosing pump will readjust it.

ATTENTION

If the pump is already operated at 100% stroke frequency, the flow rate cannot be adjusted upward any more. If the desired value is not reached, the warning message "Flow rate too low" will be displayed.

The maximum adjustable desired value is limited by the internally determined stroke length.

Example:

The calibration at 50% stroke length results in a flow rate of 10l/h (at 100% stroke frequency).

If a target value of 8l/h is entered, then the stroke frequency is at first accordingly reduced to 80%.

The flow meter measures a delivery rate of 7.9l/h.

The internal control increases the stroke frequency to 81% in order to achieve 8l/h.

The maximum desired value in this case is 10l/h.

It can be changed via the stroke length adjustment (+/- 10%).

Internal control:

100 % stroke frequency → Measured in litres: 10l/h

Desired value: 8 l/h → 80% stroke frequency

80% stroke frequency → Actual value: 7.9 l/h

8 l/h → 81 % stroke frequency

ATTENTION

In order to allow an effective regulation of the flow rate, it must be ensured that the preset desired value is achieved at a stroke frequency of < 100%. The maximum desired stroke frequency should be approx. 80% so that the flow rate can be readjusted if the desired value is not reached.

NOTE

The desired value can be preset in l/h manually (MANUAL operating mode) or by an analog signal (ANALOG) after the dosing pump was calibrated.

Calibration

The calibration is used to activate the flow rate indicator. Calibration is always done in the same way, no matter whether a flow meter is connected or not.

ATTENTION

Calibration is performed with a fixed stroke length. The calibration remains valid even if the stroke length is changed by up to +/- 10%. If this calibration range is exceeded, then the warning message "Out of range" will be shown.

Sequence of calibration:

ATTENTION

Prior to the calibration of the flow rate indicator with connected flow meter, the sensor type (>SENSOR<) must be set. If no sensor type is set (OFF), then the calibration will only activate the standard flow rate indicator.

ATTENTION

Pay attention to the safety data sheet relating to the dosing medium!

- Lead the suction pipe into a calibration pot filled with the dosing medium – the pressure pipe must be installed in final position, i.e. the operating conditions (backpressure, etc.) must be fulfilled.
- When the suction pipe is empty the dosing medium must be drawn in (MANUAL operating mode, keep the pump running)
- Set the stroke length with which the pump should be calibrated (can also be done via the manual stroke length adjustment)
- Note the filling level in the calibration pot (= base quantity)

- go to the main menu and select the CALIBRATION menu
- press the ENTER key to access the field for entering the number of calibration strokes
- enter the desired stroke number (at least 200!)
the higher the stroke number the more accurate the calibration!
- to start the calibration, press the ENTER button
- the dosing pump performs the preset number of strokes
- Determination of the pumped quantity
(= difference between base quantity and remaining quantity in the calibration pot).
- entry of the determined quantity
- the calibration of the pump is completed.

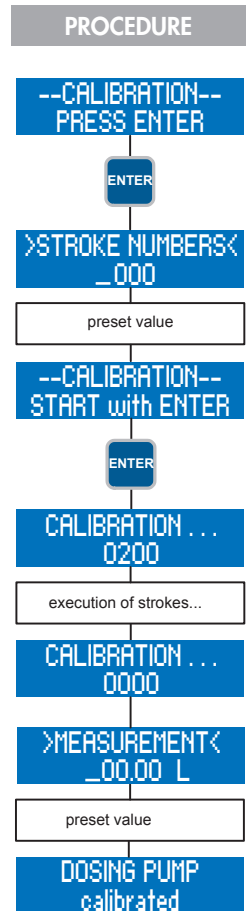

i NOTE

After the dosing pump has been calibrated, calibration will automatically be set to ON.

! ATTENTION

If the operating conditions are changed (supply pipe, backpressure, etc.), then the dosing pump must be newly calibrated. Otherwise, the flow rate indicator might be inaccurate!

System

The system settings do not depend on the operating mode. These include:

- Language
- Profibus address
- Calibration
- Factory settings
- System time

>LANGUAGE<

You can select between GERMAN, ENGLISH and SPANISH menu texts.

>PROFIBUS-ADR.<

Here, the Profibus address of the pump can be set from 1 – 126.
The pump is restarted afterwards and the address will be accepted

>CALIBRATION<

The calibration of the pump can be switched ON and OFF.
If the calibration is set to ON and the dosing pump has been calibrated, then the flow rate indicator is activated.
If the calibration is set to OFF and/or the pump has not been calibrated, then the flow rate indicator is not activated.

>FACTORY SETTINGS<

The factory settings can be loaded. To do so, set YES.

! ATTENTION

After loading the factory default settings, all previous user-defined settings are irrevocably overwritten.

>SYSTEM TIME<

The system time must be adjusted manually.

! ATTENTION

If the supply voltage is switched off, then the system time will be reset to 00:00. This means it must be set again.

Totalizer

The totalizer indicates the total volume conveyed, the total strokes and the pump's operating hours. These values are for information purposes and cannot be reset.

Password

Two password levels are provided to increase the operating safety of the pump. The passwords for these levels consist of a four-digit number code and are individually selectable.

Password 01 (PW01) is used to protect the setting of the operating mode (Level 01). This password can be activated and disabled (when leaving the factory, it is disabled).

Password 02 (PW02) protects all further setting options of the main menu (Level 02, see "Menu guide"). This password protection cannot be disabled.

i NOTE

If, during the first password request (Level 01), password 02 has been entered, then Level 02 is also automatically activated..

⚠ ATTENTION

The passwords are factory set as follows:

- Password 01: 9990 (disabled)
- Password 02: 9021 (cannot be disabled!)

go to the MAIN MENU and select the menu item PASSWORD

pressing the ENTER button opens the setting menu for the PW01 mode.

Press the DOWN button to access the setting for Password 01.

value entry for Password 01 is enabled after pressing the ENTER button.

after having entered Password 01, press the DOWN button to access the setting for Password 02.

value entry for Password 02 is enabled after pressing the ENTER button.

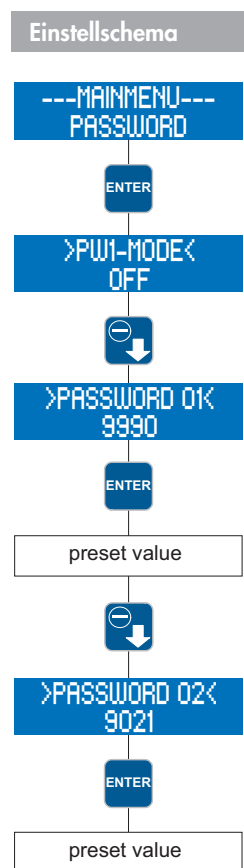

! ATTENTION

There is an automatic "Logout" after 5 min of inactivity in the "Operating modes" view. Afterwards, the password must be entered again.

! ATTENTION

You should note down the passwords and keep them in a safe place. If the passwords get lost, the pump can no longer be reconfigured on-site and must be returned to the manufacturer for configuration.

Info

The Info menu item contains information about the hardware and software version of the pump.

Extras**Slow Mode (only C410.2)**

---EXTRAS---
SLOW-MODE

In Slow mode the pump is operated at reduced speed. This is useful, for example, if media with a high viscosity are to be conveyed. The following items can be adjusted

- SLOW-MODE
- Speed

>SLOW-MODE<

Activating/deactivating the Slow-Mode.

>SPEED<

The speed is input with the Slow mode activated. The speed can be selected between 100 and 30%.

i NOTE

The speed input in the Slow-Mode corresponds to the maximum stroke frequency with which the pump can be operated. The maximum possible flow rate is reduced correspondingly!

Speed control (nur C410.2)

>SPEED<
AUTO

The motor speed is adjusted to the stroke frequency.
The pump switches in the Stop&Go mode if a stroke frequency of 30% is not reached.

>SPEED<
STROKE FREQ.

Stop&Go mode over the complete stroke frequency range, i.e. each stroke is executed at full motor speed.

Dosing monitoring

---EXTRAS---
DOSING MONITOR.

The connection of a flow monitor to the dosing pump will enable the monitoring of the flow rate. The connection of a flow meter to the dosing pump will provide a more detailed flow rate indication incl. regulation of the flow rate.



ATTENTION

Prior to the calibration of the flow rate indicator with connected flow meter, the sensor type (>SENSOR<) must be set. If no sensor type is set (OFF), then the sensor signal will not be considered during calibration

The following items can be adjusted:

- Sensor
- Function
- Fault strokes
- Alarm limit
- Calibration

>SENSOR<

Selection of the connected **sera** flow monitor or **sera** flow meter.

>FUNCTION<

Selection of the dosing monitoring function. It can be selected whether the dosing monitoring should trigger a warning message (MESSAGE) or a switch-off of the pump (DOSING PUMP STOP).

>FAULT STROKES<

Number of fault strokes at which a connected flow monitor triggers the dosing monitor. The factory setting is 10 fault strokes. This means that the dosing monitor will react if the flow monitor does not give a stroke confirmation to the pump for the duration of ten consecutive strokes.

>ALARM LIMIT<

Alarm limit at which a connected flow meter triggers the dosing monitor. The entered value corresponds to the percental part of the desired flow rate.
The factory setting is 80%. This means that the dosing monitor will react if a connected flow meter measures a flow rate which is lower than 80% of the set desired flow rate.

---CALIBRATION---

see „Calibration“.

Diaphragm rupture detection

---EXTRAS---
DIAPHRAGM RUPT.

The dosing pump can be upgraded with an optional diaphragm rupture detection unit.

This device monitors the delivery diaphragm.

The following items can be adjusted:

- Input signal
- Sensitivity

>INPUT SIGNAL<

Selection between switch off (OFF) of the diaphragm rupture electrode and a configuration as NO or NC.

ATTENTION

The contact mode NO should be set with single and double diaphragm pumps if conductive media are conveyed. In the case of single diaphragm pumps the diaphragm rupture monitor is only operative with conductive media. The contact mode NC should be set for diaphragm pumps if non-conductive media with conductive buffer fluid are conveyed. These are factory settings.

>SENSITIVITY<

Input of the sensitivity of the diaphragm rupture electrode in percent. This enables an adaptation to the conductivity of the pumped medium. In case of poorly conductive media, the sensitivity must be set to a high value (e.g. 100% at approx. $4\mu\text{S}/\text{cm}$); in case of highly conductive media, the sensitivity must be set to a low value (e.g. 10% at approx. $50\mu\text{S}/\text{cm}$)

NOTE

When leaving the factory, the sensitivity is preset to 50%.
This corresponds to a minimum conductivity of the pumped medium of approx. $10\mu\text{S}/\text{cm}$.
The minimum conductivity at 100% sensitivity is $4\mu\text{S}/\text{cm}$.

Level monitoring



The connection of a **sera** suction lance enables the monitoring of the filling level in the dosing tank. The following items can be adjusted:

- Pre-alarm
- Dry run

>PRE-ALARM< and >DRY RUN< respectively

Configuration of the two level inputs. It can be selected between either the switch off (OFF) of the input and a configuration as NC (normally closed, opening when floating down) or NO (normally open, closing when floating down).

When leaving the factory, both level inputs are configured as NO.

Configuration of the level input		
Configuration	Pre-alarm	Dry run
1	NO	NO
2	NO	NC
3	NC	NC

Configuration 1

When leaving the factory, this configuration is preset. A 1- or 2-stage level monitoring with “closing when floating down” contacts (pre-alarm and dry run or dry run only) can be connected.

Configuration 2

This configuration must be selected when a 1-stage level monitoring (dry run only) with “opening when floating down” contact is connected.

Configuration 3

This configuration must be selected when a 2-stage level monitoring with “opening when floating down” contacts (pre-alarm and dry run) is connected.

Bus error messages

Error message			Possible cause	Corrective action	
Fault bus module	Bus offline	Bus fail safe!			
			■	Internal error of the communication module	Please contact the manufacturer
			■	Connector plug not fitted to the pump	Connect connector plug to the pump via the Y-/T- distributing piece
			■	Master system failed	Check the master system
			■	Bus connection in segment interrupted	Check bus connections in the segment
			■	Terminating resistor not connected/activated	Connect/activate terminating resistor to the first and last subscriber
			■	Master system in "Stop" state	Look for the cause of the error in the master system and correct. Switch the master in the "Run" state.
			■	Master system is in the fail safe state	Look for the reason of the fail safe state in the master system
			■	Operating mode ZERO for the pump preselected (see Setting of the operating mode)	Select the desired operating mode for the pump
			■	Master system sends data length ZERO	Check the master system

FOLLOW US



sera GmbH
sera-Str. 1
34376 Immenhausen
Germany
Tel. +49 5673 999 00
Fax +49 5673 999 01
info@sera-web.com
www.sera-web.com

TM13-00 EN 10/2020. **sera**® ist eine eingetragene Marke der **sera GmbH**.
Änderungen vorbehalten. **sera** übernimmt keine Haftung für Irrtümer oder Druckfehler.